

Thermador 

Q1 2025

PRICE LIST

Consumer UMRP



TABLE of CONTENTS

Consumer UMRP Price List Q1 2025

This price list supersedes all previous price lists. Prices listed herein do not include applicable state or local taxes.

REFRIGERATION

Refrigerator Columns	1-2
Freezer Columns	1-4
Built-In Bottom Freezer Refrigeration	1-7
Freestanding Refrigeration	1-10
Suggested Combinations	1-11
Wine Refrigeration	1-12
Under-Counter	1-14
Glass Door Refrigeration Units.....	1-14
Drawer Refrigeration/Freezer Units.....	1-14
Glass Door Wine Preservation Units.....	1-14
Accessories	1-15
Handles.....	1-15
Refrigerator Columns.....	1-16
Freezer Columns.....	1-17
Bottom Freezer Refrigeration.....	1-18
Freestanding Refrigeration.....	1-20
Under-Counter Drawer Accessories.....	1-21
Wine Refrigeration.....	1-21
Column Quick Reference Guide	1-22

BUILT-IN COFFEE MACHINE

Built-In Coffee Machine.....	2-1
Accessories.....	2-1

BUILT-IN OVENS

Overview.....	3-1
Masterpiece® Series	3-2
30" Masterpiece® Ovens.....	3-2
Accessories.....	3-6
Professional Series	3-7
30" Professional Series Ovens.....	3-7
Microwaves	3-12
Built-In Microwaves.....	3-12
MicroDrawer® Microwaves.....	3-12
Over-the-Range Microwave.....	3-13
Speed Ovens	3-13
Warming Drawers	3-14
Accessories	3-14

COOKTOPS

Gas Cooktops	4-1
Glass Ceramic Induction Cooktops	4-3
Glass Ceramic Electric Cooktops	4-6
Accessories	4-7

PROFESSIONAL SERIES RANGES AND RANGETOPS

Overview.....	5-1
Professional Rangetops	5-2
Pro Harmony® Series	5-4
Induction Ranges.....	5-4
Dual-Fuel Ranges.....	5-5
Gas Ranges.....	5-7
Accessories.....	5-9
Pro Grand® Series	5-12
Dual-Fuel with Steam Ranges.....	5-12
Dual-Fuel Ranges.....	5-14
Gas Ranges.....	5-17
Accessories.....	5-18

VENTILATION

Overview.....	6-1
Wall Hoods	6-2
Masterpiece® Series.....	6-2
Accessories—Masterpiece® Series.....	6-3
Professional Series.....	6-5
Accessories—Professional.....	6-7
Chimney Wall Hoods	6-9
Masterpiece® Series.....	6-9
Professional Series.....	6-10
Accessories.....	6-11
Island Hoods	6-13
Masterpiece® Series.....	6-13
Accessories.....	6-14
Custom Inserts	6-15
Professional Series.....	6-16
Masterpiece® Series.....	6-15
Professional Series.....	6-16
Accessories.....	6-17
Downdraft	6-18
Masterpiece® Series.....	6-18
Components.....	6-19
Blower Accessories.....	6-22

DISHWASHERS

Built-In Dishwashers	7-1
Accessories	7-2

INDEX

Index.....	8-1
------------	-----

Conditions of Sale

Returned Goods

No merchandise may be returned without prior approval. Please contact your sales representative for return authorization.

F.O.B. Origin

All products are sold F.O.B. BSH Home Appliances, New Bern, North Carolina. For special freight and billing terms, refer to current program in effect.

Freedom® Collection REFRIGERATION

Thermador's ingenious Freedom® Collection lets you take your kitchen designs beyond anything you've ever imagined. Featuring unique modular construction, built-in refrigeration columns, freezer columns, bottom freezers and wine refrigeration are available in multiple widths ranging from 18" to 36".

To order, please follow this 4-step process:

Step 1

Select a Panel-Ready Column



Step 2

Select a Stainless Steel Panel or Use a Custom Panel



+

+

Step 3

Select a Stainless Steel Handle or Use a Custom Handle



+

Step 4

Select Optional Accessories



HEATRKIT20

Freedom® Heater Kit

For columns that are less than 6" apart but not side by side, or for nontraditional side-by-side combinations, without freezer column. See page 1-16.



FRAMEKIT10

Freedom® Frame Kit

For any custom column installation in 24-inch deep cutouts. With two metal side trims whose placement between the interior cutout wall and the appliance helps overcome the challenge of unfinished cabinet returns. See page 1-16.

To enhance the Freedom® Collection, please see our accessories section on page 1-11.

The information contained in this document is BSH Home Appliances Corporation's proprietary and confidential information. The release or disclosure of this information without the prior written consent of BSH Home Appliances Corporation is strictly forbidden.

REFRIGERATOR COLUMNS

This price list supersedes all previous price lists. Prices listed herein do not include applicable state or local taxes.

Model Number	Description	UMRP	MSRP
--------------	-------------	------	------

All 23.5"/24"/30"/36" Refrigerator Columns include the following features:

- Fully Flush
- Stainless steel interior
- Star-K certified
- Freedom® hinge
- Full-extension SoftClose® drawers
- ENERGY STAR® certified
- All-LED sidewall filtered theater lighting
- TFT Control
- Extremely quiet
- Cold Air System
- Full-length cantilever racks
- Reversible door swing
- ThermaFresh® system
- Door open alarm
- Home Connect
- Carbon air filter
- Open door assist
- Sabbath/Economy/Vacation modes
- SuperCool function

Step 1: Refrigerator Columns



T24IR905SP	24" Fresh Food Column	7,499	8,249
T30IR905SP	30" Fresh Food Column	7,999	8,799
T36IR905SP	36" Fresh Food Column	8,499	9,349

The information contained in this document is BSH Home Appliances Corporation's proprietary and confidential information. The release or disclosure of this information without the prior written consent of BSH Home Appliances Corporation is strictly forbidden.

This price list supersedes all previous price lists. Prices listed herein do not include applicable state or local taxes.

Model Number	Description	UMRP	MSRP
--------------	-------------	------	------

Step 2: Panels

All Thermador Refrigerator Columns are panel ready. Apply custom panels or choose one of the following stainless steel panel options:

Flat Stainless Steel Door Panels for Flush Installations

TFL24IR800	24" Stainless Steel Panel	525	599
TFL30IR800	30" Stainless Steel Panel	580	649
TFL36IR900	36" Stainless Steel Panel	1,050	1,199



Flat Stainless Steel Door Panels with No Holes

TFL24IR905	24" Single Door No Hole Flat Panel	525	599
TFL30IR905	30" Single Door No Hole Flat Panel ¹	580	649
TFL36IR905	36" Single Door No Hole Flat Panel	1,050	1,199

Step 3: Handles

For stainless steel handle options, please see page 1-15

Step 4: Optional Accessories

FRAMEKIT10	Freedom [®] Frame Kit (For use with any custom column for installation in 24-inch (610 mm) deep cutouts. With two metal side trims whose placement between the interior cutout wall and the appliance helps overcome the challenge of unfinished cabinet returns. Note: Included with all pre-assembled bottom freezers)	105	119	
HEATRKIT20	Freedom [®] Heater Kit (For use when columns are less than 6" apart but not side by side, or for nontraditional side-by-side combinations, without freezer column. This kit is also recommended to be ordered for use with any installation in areas that are subject to high humidity (>65%), or located next to an outside wall.)	599	699	

¹ Units compatible with 30" columns, but should be installed to units with SoftClose[®] Doors.

The information contained in this document is BSH Home Appliances Corporation's proprietary and confidential information. The release or disclosure of this information without the prior written consent of BSH Home Appliances Corporation is strictly forbidden.

This price list supersedes all previous price lists. Prices listed herein do not include applicable state or local taxes.

Model Number	Description	UMRP	MSRP
--------------	-------------	------	------

All 18"/24"/30"/36" Freezer Columns Include the Following Features:

- Fully Flush
- Freedom® hinge
- All-LED sidewall filtered theater lighting
- Full-extension SoftClose® drawers
- SuperFreeze® function
- Height-adjustable glass shelves
- TFT Control
- Stainless steel interior
- Full-length cantilever racks
- Filtered internal diamond ice maker
- Door open alarm
- Open door assist
- Sabbath/Economy/Vacation modes
- Star-K certified
- ENERGY STAR® certified
- Extremely quiet
- Side-by-side kit included
- Home Connect

Step 1: Freezer Columns with Internal Ice Maker

- Ice drawer with ice bin
- Reversible door swing



T18IF905SP	18" Freezer Column (Internal Ice Maker)	6,999	7,699
T24IF905SP	24" Freezer Column (Internal Ice Maker)	7,499	8,249
T30IF905SP	30" Freezer Column (Internal Ice Maker)	7,999	8,799
T36IF905SP	36" Freezer Column (Internal Ice Maker)	8,499	9,349



Step 1: Freezer Columns with External Ice and Water Dispenser

- External Filtered Ice and Water Dispenser
- FreeFlow® diamond ice system
- Proximity sensor on dispenser
- Capacitive touch control dispenser
- Available in right-hand or left-hand door swing (not reversible)
- Stainless steel interior

T18ID905LP	18" Freezer Column (External Ice and Water Dispenser, Left Hinge)	7,999	8,799
T18ID905RP	18" Freezer Column (External Ice and Water Dispenser, Right Hinge)	7,999	8,799
T24ID905LP	24" Freezer Column (External Ice and Water Dispenser, Left Hinge)	8,499	9,349
T24ID905RP	24" Freezer Column (External Ice and Water Dispenser, Right Hinge)	8,499	9,349



The information contained in this document is BSH Home Appliances Corporation's proprietary and confidential information. The release or disclosure of this information without the prior written consent of BSH Home Appliances Corporation is strictly forbidden.

This price list supersedes all previous price lists. Prices listed herein do not include applicable state or local taxes.

Model Number	Description	UMRP	MSRP
--------------	-------------	------	------

Step 2: Panels

All Thermador Freezer Columns are panel ready. Apply custom panels or choose one of the following stainless steel panel options:

Flat Stainless Steel Door Panels for Flush Installations

TFL18IR800	18" Stainless Steel Panel	475	529
TFL18ID800	18" Stainless Steel Panel for External Dispenser	475	529
TFL24IR800	24" Stainless Steel Panel	525	599
TFL24ID800	24" Stainless Steel Panel for External Dispenser	525	599
TFL30IR800	30" Stainless Steel Panel	580	649
TFL36IR900	36" Stainless Steel Panel	1,050	1,199



Flat Stainless Steel Door Panels with No Holes

TFL18IR905	18" Single Door No Hole Flat Panel ¹	475	529
TFL18ID905	18" External Water Dispenser No Hole Flat Panel	475	529
TFL24IR905	24" Single Door No Hole Flat Panel	525	599
TFL24ID905	24" External Water Dispenser No Hole Flat Panel	525	599
TFL30IR905	30" Single Door No Hole Flat Panel	580	649
TFL36IR905	36" Single Door No Hole Flat Panel	1,050	1,199

Step 3: Handles

For stainless steel handle options, please see page 1-15.

Step 4: Optional Accessories

FRAMEKIT10	Freedom® Frame Kit (For use with any custom column for installation in 24-inch (610 mm) deep cutouts. With two metal side trims whose placement between the interior cutout wall and the appliance helps overcome the challenge of unfinished cabinet returns. Note: Included with all pre-assembled bottom freezers)	105	119	
HEATRKIT20	Freedom® Heater Kit (For use when columns are less than 6" apart but not side by side, or for nontraditional side-by-side combinations, without freezer column. This kit is also recommended to be ordered for use with any installation in areas that are subject to high humidity (>65%), or located next to an outside wall.)	599	699	

¹ Units compatible with 18" columns, but should be installed to units with SoftClose® Doors.

The information contained in this document is BSH Home Appliances Corporation's proprietary and confidential information. The release or disclosure of this information without the prior written consent of BSH Home Appliances Corporation is strictly forbidden.

BUILT-IN BOTTOM FREEZER REFRIGERATION

This price list supersedes all previous price lists. Prices listed herein do not include applicable state or local taxes.

Model Number	Description	UMRP	MSRP
--------------	-------------	------	------

All 30" Bottom Freezers Include the Following Features:

- Fully Flush—installs framed or fully flush
- Touchscreen control panel
- Vivid LED sidewall and theater style lighting
- Full-Extension SoftClose® drawers
- SoftClose® doors
- Temperature and humidity controlled drawers
- Full-width deli drawer
- Internal ice maker with filtered diamond ice and ice scoop
- SuperCool/SuperFreezer®
- Adjustable shelves and door bins
- Gallon size door bins
- Two evaporators
- Two compressors
- Carbon air filter
- Door open alarm
- Sabbath/Economy/Vacation modes
- Star-K certified
- ENERGY STAR® certified
- Extremely quiet
- Refrigerator door swing reversible
- Home Connect

30" Bottom Freezers

Step 1: Bottom Freezers with Stainless Steel Interior

- Open Door Assist
- ThermaFresh® System

T30IB905SP	30" Bottom Freezer, Panel ready	9,499	10,449
------------	---------------------------------	-------	--------

Discontinues April



T30IB905SP



Step 2: Panels

All Thermador Bottom Freezers are panel ready. Apply custom panels or choose one of the following stainless steel panel options:

Flat Stainless Steel Door Panels for Flush Installations

TFL30IB800	30" Stainless Steel Panel Set (Bottom Freezer)	580	649
------------	--	-----	-----

Flat Stainless Steel Door Panels with No Holes

TFL30IB905	30" Stainless Steel Panel Set (Bottom Freezer)	580	649
------------	--	-----	-----

Step 3: Handles

For stainless steel handle options, please see page 1-15.

Step 4: Optional Accessories

FRAMEKIT10	Freedom® Frame Kit (For use with any custom column for installation in 24-inch (610 mm) deep cutouts. With two metal side trims whose placement between the interior cutout wall and the appliance helps overcome the challenge of unfinished cabinet returns. Note: Included with all pre-assembled bottom freezers)	105	119
------------	---	-----	-----



FRAMEKIT10

HEATRKIT20	Freedom® Heater Kit (For use when columns are less than 6" apart but not side by side, or for nontraditional side-by-side combinations, without freezer column. This kit is also recommended to be ordered for use with any installation in areas that are subject to high humidity (>65%), or located next to an outside wall.)	599	699
------------	---	-----	-----



HEATRKIT20

The information contained in this document is BSH Home Appliances Corporation's proprietary and confidential information. The release or disclosure of this information without the prior written consent of BSH Home Appliances Corporation is strictly forbidden.

BUILT-IN BOTTOM FREEZER REFRIGERATION

This price list supersedes all previous price lists. Prices listed herein do not include applicable state or local taxes.

Model Number	Description	UMRP	MSRP
--------------	-------------	------	------

Units available pre-assembled with stainless steel panels and Professional or Masterpiece® handles OR custom panel ready.¹

30" Bottom Freezers

- Open Door Assist
- ThermaFresh® System

T30BB915SS	30" Bottom Freezer, two-door, Masterpiece® Handles	10,999	12,099
T30BB925SS	30" Bottom Freezer, two-door, Professional Handles	10,999	12,099

Both SKUs discontinue April



T30BB925SS



- | | | |
|---|---|--|
| <ul style="list-style-type: none"> • ThermaFresh® Pro crisper drawer automatically selects the optimal temperature and humidity to keep food fresh longer • Internal water dispenser with UltraClarityPro® water filter | <ul style="list-style-type: none"> • Full color touchscreen control panel • Three cameras in fridge for inventory management • Stainless steel interior • Three-tier freezer drawer | <ul style="list-style-type: none"> • Non-slip mats in door bins and drawers prevent items from shifting • Door Open Alarm • Star-K certified • Trim kit included |
|---|---|--|

NEW T30IB100SP	30" Bottom Freezer, Two-Door, Custom-Panel Ready	9,799	10,799
---------------------------------------	--	-------	--------

Available May



T30IB100SP

Image not final; May not be true representation.



¹ Custom panel option not available for 30" bottom freezers T30BB9_5SS.

The information contained in this document is BSH Home Appliances Corporation's proprietary and confidential information. The release or disclosure of this information without the prior written consent of BSH Home Appliances Corporation is strictly forbidden.

BUILT-IN BOTTOM FREEZER REFRIGERATION

This price list supersedes all previous price lists. Prices listed herein do not include applicable state or local taxes.

Model Number	Description	UMRP	MSRP
--------------	-------------	------	------

Units available pre-assembled with stainless steel panels and Professional or Masterpiece® handles OR custom panel ready.

All 36" Bottom Freezers and French Door Bottom Freezers Include the Following Features:

- | | | |
|--|---|---|
| <ul style="list-style-type: none"> Installs framed or fully flush All new touchscreen display control panel Vivid LED sidewall and theater style lighting Cameras in fridge for inventory management ThermaFresh® Pro temperature and humidity control preserves freshness ThermaFlex Drawer temperature adjusts from fridge to freezer for maximum versatility Full-Extension SoftClose® drawers | <ul style="list-style-type: none"> SoftClose® doors Deli drawer for convenient access to small items Non-slip mats in door bins and drawers prevent items from shifting Internal water dispenser with UltraClarityPro® water filter Elevated internal ice maker with diamond ice and ice scoop SuperCool and SuperFreeze® functions Adjustable split level shelving Gallon size door bins | <ul style="list-style-type: none"> Two compressors Two evaporators Stainless steel interior Door Open Alarm Sabbath/Vacation/Economy modes Star-K certified ENERGY STAR® certified Home Connect Trim kit included Refrigerator door swing reversible (T36BB110SS, T36BB120SS, T36IB100SP) |
|--|---|---|

Bottom Freezers

T36BB110SS	36" Bottom Freezer, Reversible Door, Stainless Steel, Masterpiece® Handles	11,799	12,999
T36BB120SS	36" Bottom Freezer, Reversible Door, Stainless Steel, Professional Handles	11,799	12,999
T36IB100SP	36" Bottom Freezer, Reversible Door, Custom-Panel Ready	10,299	11,349



T36BB120SS



French Door Bottom Freezers

T36BT110NS	36" French Door Bottom Freezer, Stainless Steel, Masterpiece® Handles	12,299	13,549
T36BT120NS	36" French Door Bottom Freezer, Stainless Steel, Professional Handles	12,299	13,549
T36IT100NP	36" French Door Bottom Freezer, Custom-Panel Ready	10,799	11,899



T36BT110NS



The information contained in this document is BSH Home Appliances Corporation's proprietary and confidential information. The release or disclosure of this information without the prior written consent of BSH Home Appliances Corporation is strictly forbidden.

BUILT-IN BOTTOM FREEZER REFRIGERATION

This price list supersedes all previous price lists. Prices listed herein do not include applicable state or local taxes.

Model Number	Description	UMRP	MSRP
--------------	-------------	------	------

Units available pre-assembled with stainless steel panels and Professional or Masterpiece® handles OR custom panel ready.

All 42" and 48" French Door Bottom Freezers Include the Following Features:

- Installs framed or fully flush
- All new touchscreen display control
- Vivid LED sidewall and theater style lighting
- Cameras inside refrigerator compartment for inventory management
- ThermaFresh® Pro temperature and humidity control preserves freshness
- ThermaFlex Drawer temperature adjusts from fridge to freezer for maximum versatility
- Full-Extension SoftClose® drawers
- SoftClose® Doors
- Deli drawer for convenient access to small items
- Non-slip mats in door bins and drawers prevent items from shifting
- Internal water dispenser with UltraClarityPro® water filter
- **Elevated dual ice maker with diamond ice, entertaining ice and ice scoop**
- SuperCool and SuperFreeze® functions
- Adjustable split level shelving
- Gallon size door bins
- Two compressors
- Two evaporators
- Stainless steel interior
- Door Open Alarm
- Sabbath/Vacation/Economy modes
- Star-K certified
- ENERGY STAR® certified
- Home Connect
- Trim kit included

French Door Bottom Freezers

T42BT110NS	42" French Door Bottom Freezer, Stainless Steel, Masterpiece® Handles	13,999	15,399
T42BT120NS	42" French Door Bottom Freezer, Stainless Steel, Professional Handles	13,999	15,399
T42IT100NP	42" French Door Bottom Freezer, Custom-Panel Ready	12,499	13,749
T48BT110NS	48" French Door Bottom Freezer, Stainless Steel, Masterpiece® Handles	15,999	17,599
T48BT120NS	48" French Door Bottom Freezer, Stainless Steel, Professional Handles	15,999	17,599
T48IT100NP	48" French Door Bottom Freezer, Custom-Panel Ready	14,499	15,949



T42BT120NS



T48BT120NS



The information contained in this document is BSH Home Appliances Corporation's proprietary and confidential information. The release or disclosure of this information without the prior written consent of BSH Home Appliances Corporation is strictly forbidden.

FREESTANDING REFRIGERATION

This price list supersedes all previous price lists. Prices listed herein do not include applicable state or local taxes.

Model Number	Description	UMRP	MSRP
--------------	-------------	------	------

For faster installation, all units have been preassembled with stainless steel doors and Professional or Masterpiece® Handles.

All Freestanding 36" French Door Refrigerators Include the Following Features:

- Counter-depth 72" Tall Appliance
- Built-in Look Exterior Design
- Illuminated Back Wall
- ThermaFresh® System for Temperature and Humidity Control
- Stainless Steel ThermaFresh® Mats
- Internal Water Dispenser
- Diamond Ice Maker
- Filtered ice and water
- SuperCool function
- SuperFreeze® function
- Gallon door bins
- Dual Evaporator
- Dual Compressor
- Carbon air filter
- Door open alarm
- Sabbath/Economy/Vacation modes
- ENERGY STAR® certified
-  HomeConnect

Bottom Freezers with Stainless Steel Interior

- Star-K certified

T36FT810NS	36" 3-Door Freestanding French Door Refrigerator with Masterpiece® Handles	4,999	5,499
T36FT820NS	36" 3-Door Freestanding French Door Refrigerator with Professional Handles	4,999	5,499



T36FT810NS



Bottom Freezers with Stainless Steel Interior

- Offers flexible and versatile storage options with a convenient multi-door format.

NEW T36FL810NS	36" 4-Door Freestanding French Door Refrigerator with Masterpiece® Handles	4,999	5,499
NEW T36FL821NS	36" 4-Door Freestanding French Door Refrigerator with Professional Handles	4,999	5,499



T36FL810NS



Both available January

The information contained in this document is BSH Home Appliances Corporation's proprietary and confidential information. The release or disclosure of this information without the prior written consent of BSH Home Appliances Corporation is strictly forbidden.

This price list supersedes all previous price lists. Prices listed herein do not include applicable state or local taxes.

Suggested Combinations

These suggestions are just an example of the extensive range of combinations possible with the Freedom® Collection.

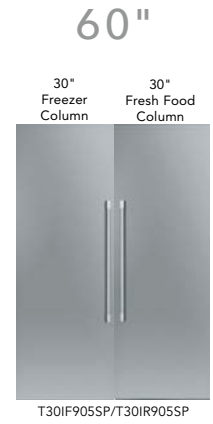
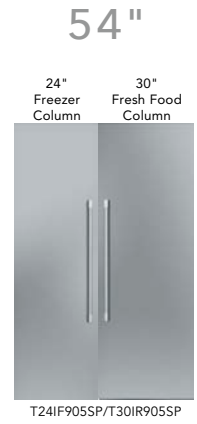

Please make sure to order HEATRKIT20 when installation is less than 6" apart but not connected, or for nontraditional side-by-side combinations without freezer column.

A HEATRKIT20 is recommended for use with any installation in areas that are subject to extreme humidity.

*IWD = Ice and Water Dispenser

The information contained in this document is BSH Home Appliances Corporation's proprietary and confidential information. The release or disclosure of this information without the prior written consent of BSH Home Appliances Corporation is strictly forbidden.

This price list supersedes all previous price lists. Prices listed herein do not include applicable state or local taxes.



Model Number	Description	UMRP	MSRP
All 18"/24" Wine Refrigeration Include the Following Features:			
<ul style="list-style-type: none"> Fully Flush Portable aluminum and wenge wood wine presenter Full-extension completely enclosed exotic wood shelves Fully adjustable temperature zones: 18" column-two; 24" column-three 	<ul style="list-style-type: none"> Independent humidity control TFT control Freedom® hinge Adjustable LED lighting Diamond shaped dowels for vibration control Glass door with UV protection 	<ul style="list-style-type: none"> Door open alarm Open door assist Sabbath/Economy/Vacation modes Star-K certified Bottle capacity: 18" column-52 bottles; 24" column-92 bottles (750 ml) Home Connect 	

Step 1: Wine Refrigeration



T18IW905SP

T24IW905SP

T18IW905SP	18" Wine Preservation Column 2 - Zone Temperature Control	6,499	7,149	 
T24IW905SP	24" Wine Preservation Column 3 - Zone Temperature Control	6,999	7,699	

1 Units compatible with 18" columns, but should be installed to units with SoftClose® Doors.

The information contained in this document is BSH Home Appliances Corporation's proprietary and confidential information. The release or disclosure of this information without the prior written consent of BSH Home Appliances Corporation is strictly forbidden.

This price list supersedes all previous price lists. Prices listed herein do not include applicable state or local taxes.

Model Number	Description	UMRP	MSRP
--------------	-------------	------	------

Step 2: Panels

All Thermador Wine Refrigeration are panel ready. Apply custom panels or choose one of the following stainless steel panel options:

Flat Stainless Steel Door Panels for Flush Installations

TFL18IW800	18" Stainless Steel Panel	475	529
TFL24IW800	24" Stainless Steel Panel	525	599

Flat Stainless Steel Door Panels with No Holes

TFL18IW905	18" Wine No Hole Flat Panel	475	529
TFL24IW905	24" Wine No Hole Flat Panel ¹	525	599

Step 3: Handles

For stainless steel handle options, please see page 1-15.

Step 4: Optional Accessories

FRAMEKIT10	<p>Freedom® Frame Kit</p> <p>(For use with any custom column for installation in 24-inch (610 mm) deep cutouts. With two metal side trims whose placement between the interior cutout wall and the appliance helps overcome the challenge of unfinished cabinet returns. Note: Included with all pre-assembled bottom freezers)</p>	105	119	 <p>FRAMEKIT10</p>
HEATRKIT20	<p>Freedom® Heater Kit</p> <p>(For use when columns are less than 6" apart but not side by side, or for nontraditional side-by-side combinations, without freezer column. This kit is also recommended to be ordered for use with any installation in areas that are subject to high humidity (>65%), or located next to an outside wall.)</p>	599	699	

The information contained in this document is BSH Home Appliances Corporation's proprietary and confidential information. The release or disclosure of this information without the prior written consent of BSH Home Appliances Corporation is strictly forbidden.

This price list supersedes all previous price lists. Prices listed herein do not include applicable state or local taxes.

Model Number	Description	UMRP	MSRP
--------------	-------------	------	------

All Under-Counter Units Include the Following Features:

- Built-in flush design
- LED lighting
- Electronic touch controls for precise temperature management
- Venting grille for full integration
- Fully flush at 24" depth
- Professional Handle, Masterpiece® Handle or custom panel options
- Star-K certified
- ENERGY STAR® certified

Glass Door Refrigeration Units

Model Number	Description	UMRP	MSRP
	<ul style="list-style-type: none"> • 5 cu. ft. • Customizable shelving • Customizable cooling modes: Fridge, Pantry and Bar 		
T24UR905LP	24" Refrigerator, Custom Panel, Left Swing	2,799	3,099
T24UR905RP	24" Refrigerator, Custom Panel, Right Swing	2,799	3,099
T24UR915LS	24" Refrigerator, Masterpiece® Handle, Left Swing	2,999	3,299
T24UR915RS	24" Refrigerator, Masterpiece® Handle, Right Swing	2,999	3,299
T24UR925LS	24" Refrigerator, Professional Handle, Left Swing	2,999	3,299
T24UR925RS	24" Refrigerator, Professional Handle, Right Swing	2,999	3,299



T24UR915LS



Drawer Refrigeration/Freezer Units

Model Number	Description	UMRP	MSRP
	<ul style="list-style-type: none"> • 4.4 cu. ft. • SoftClose® drawers • Drawer open alarm • Customizable shelving and drawer dividers • Customizable cooling modes: Fridge, Pantry and Bar • Quick Chill • Removable drawer mat for easy cleaning 		
T24UR905DP	24" Refrigerator, Custom Panel	3,999	4,399
T24UR915DS	24" Refrigerator, Masterpiece® Handle	3,899	4,299
T24UR925DS	24" Refrigerator, Professional Handle	3,899	4,299
T24UC905DP	24" Refrigerator/Freezer, Custom Panel, ice maker	3,999	4,399
T24UC915DS	24" Refrigerator/Freezer, Masterpiece® Handle, ice maker	4,199	4,649
T24UC925DS	24" Refrigerator/Freezer, Professional Handle, ice maker	4,199	4,649



T24UR915DS



T24UC915DS



Glass Door Wine Preservation Units

Under-Counter Wine Preservation Units

Model Number	Description	UMRP	MSRP
	<ul style="list-style-type: none"> • 41-bottle capacity • Full-extension wenge wood diamond wine racks • Tinted UV-resistant tempered glass door • Independent temperature control of temperature zones. 		
T24UW905LP	24" Wine Pres., Custom Panel, Left Swing	3,599	3,999
T24UW905RP	24" Wine Pres., Custom Panel, Right Swing	3,599	3,999
T24UW915LS	24" Wine Pres., Masterpiece® Handle, Left Swing	3,799	4,199
T24UW915RS	24" Wine Pres., Masterpiece® Handle, Right Swing	3,799	4,199
T24UW925LS	24" Wine Pres., Professional Handle, Left Swing	3,799	4,199
T24UW925RS	24" Wine Pres., Professional Handle, Right Swing	3,799	4,199



T24UW915LS



The information contained in this document is BSH Home Appliances Corporation's proprietary and confidential information. The release or disclosure of this information without the prior written consent of BSH Home Appliances Corporation is strictly forbidden.

This price list supersedes all previous price lists. Prices listed herein do not include applicable state or local taxes.

Model Number	Description	UMRP	MSRP					
--------------	-------------	------	------	--	--	--	--	--

Handles

Step 3: Stainless Steel Handles

When selecting Thermador stainless steel handles for the Freedom® Collection, please order the following:

- One 36" handle for each column
- One 30" handle and one 36" handle for 30" Bottom Freezers

To ensure consistency, always select the same style.

					Refrigerator Columns	Freezer Columns	Freezer Columns with IWD ¹	Bottom Freezer T30IB905SP ²	Wine Refrigeration
	MS30HNDL20	30" Masterpiece® Handle	160	179				1	
	MS36HNDL20	36" Masterpiece® Handle	160	179	1	1	1	1	1
	PR30HNDL20	30" Professional Handle	160	179				1	
	PR36HNDL20	36" Professional Handle	160	179	1	1	1	1	1













1 IWD = Ice and Water Dispenser

2 Masterpiece®: (1) MS30HNDL20, (1) MS36HNDL20. Professional: (1) PR30HNDL20, (1) PR36HNDL20





The information contained in this document is BSH Home Appliances Corporation's proprietary and confidential information. The release or disclosure of this information without the prior written consent of BSH Home Appliances Corporation is strictly forbidden.

This price list supersedes all previous price lists. Prices listed herein do not include applicable state or local taxes.

Model Number	Description	UMRP	MSRP	T24IR905SP	T30IR905SP	T36IR905SP
Refrigerator Columns						
Installation Accessories						
	FRAMEKIT10 Freedom® Frame Kit (For use with any custom column for installation in 24-inch (610 mm) deep cutouts. With two metal side trims whose placement between the interior cutout wall and the appliance helps overcome the challenge of unfinished cabinet returns. Note: Included with all pre-assembled bottom freezers)	105	119	•	•	•
	HEATRKIT20 Freedom® Heater Kit (For use when columns are less than 6" apart but not side by side, or for nontraditional side-by-side combinations, without freezer column. This kit is also recommended to be ordered for use with any installation in areas that are subject to high humidity (>65%), or located next to an outside wall.)	599	699	•	•	•
Interior Accessories for Refrigerators						
	24HFGALBIN 24" Half-Gallon Bin	170	189	•		
	30HFGALBIN 30" Half-Gallon Bin	180	199		•	
	36HFGALBIN 36" Half-Gallon Bin	190	209			•
	24PRODRAIL 24" Produce Railing	105	119	•		
	30PRODRAIL 30" Produce Railing	115	129		•	
	36PRODRAIL 36" Produce Railing	135	149			•
	LPRODBIN10 Large Produce Bin	295	329	•	•	•
	SPRODBIN10 Small Produce Bin	265	299	•	•	•









The information contained in this document is BSH Home Appliances Corporation's proprietary and confidential information. The release or disclosure of this information without the prior written consent of BSH Home Appliances Corporation is strictly forbidden.

This price list supersedes all previous price lists. Prices listed herein do not include applicable state or local taxes.

Model Number	Description	UMRP	MSRP	T18IF905SP	T24IF905SP	T30IF905SP	T36IF905SP	T18ID905LP/RP	T24ID905LP/RP
Freezer Columns									
Installation Accessories									
	FRAMEKIT10 Freedom® Frame Kit	105	119	•	•	•	•	•	•
	(For use with any custom column for installation in 24-inch (610 mm) deep cutouts. With two metal side trims whose placement between the interior cutout wall and the appliance helps overcome the challenge of unfinished cabinet returns. Note: Included with all pre-assembled bottom freezers)								
	HEATRKIT20 Freedom® Heater Kit	599	699	•	•	•	•	•	•
	(For use when columns are less than 6" apart but not side by side, or for nontraditional side-by-side combinations, without freezer column. This kit is also recommended to be ordered for use with any installation in areas that are subject to high humidity (>65%), or located next to an outside wall.)								
Interior Accessories for Freezers									
	ICEBUCKETL Ice Bucket	85	99	•	•	•	•	•	•
Filter Accessories									
	REPLFLTR55 Freedom® Replacement Water Filter	46	59	•	•	•	•	•	•









The information contained in this document is BSH Home Appliances Corporation's proprietary and confidential information. The release or disclosure of this information without the prior written consent of BSH Home Appliances Corporation is strictly forbidden.

This price list supersedes all previous price lists. Prices listed herein do not include applicable state or local taxes.

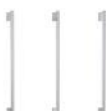
Model Number	Description	UMRP	MSRP	T30BB9_5SS	T30IB905SP	T30IB100SP	T36BB110SS	T36BB120SS	T36IB100SP	T36BT110NS	T36BT120NS	T36IT100NP	T42BT110NS	T42BT120NS	T42IT100NP	T48BT110NS	T48BT120NS	T48IT100NP	
Bottom Freezer Refrigeration																			
Installation Accessories																			
	COMBIKIT10 Connection Kit (For use with bottom freezers. Use when installing two bottom freezer refrigerators side-by-side.)	100	109			•	•	•	•	•	•	•	•	•	•	•	•	•	•
	FRAMEKIT10 Freedom® Frame Kit (For use with any custom column for installation in 24-inch (610 mm) deep cutouts. With two metal side trims whose placement between the interior cutout wall and the appliance helps overcome the challenge of unfinished cabinet returns. Note: Included with all pre-assembled bottom freezers)	105	119		•														
	FRAMEKIT30 Frame Kit (For use with any custom panel bottom freezer refrigerators installed in a 24-inch (610 mm) deep cutout. With two metal side trims whose placement between the interior cutout wall and the appliance helps overcome the challenge of unfinished cabinet returns. Note: Included with all pre-assembled bottom freezers)	225	249			•		•				•			•				•
	HEATRKIT20 Freedom® Heater Kit (For use when columns are less than 6" apart but not side by side, or for nontraditional side-by-side combinations, without freezer column. This kit is also recommended to be ordered for use with any installation in areas that are subject to high humidity (>65%), or located next to an outside wall.)	599	699		•														
Interior Accessories for Refrigerators																			
	30HFGALBIN 30" Half-Gallon Bin	180	199	•	•														
	30PRODRAIL 30" Produce Railing	115	129	•	•														
	LPRODBIN10 Large Produce Bin	295	329	•	•														
	SPRODBIN10 Small Produce Bin	265	299	•	•														
Interior Accessories for Freezers																			
	ICEBUCKETL Ice Bucket	85	99	•	•														





The information contained in this document is BSH Home Appliances Corporation's proprietary and confidential information. The release or disclosure of this information without the prior written consent of BSH Home Appliances Corporation is strictly forbidden.

This price list supersedes all previous price lists. Prices listed herein do not include applicable state or local taxes.

Model Number	Description	UMRP	MSRP	T30BB9_5SS	T30IB905SP	T30IB100SP	T36BB110SS	T36BB120SS	T36IB100SP	T36BT110NS	T36BT120NS	T36IT100NP	T42BT110NS	T42BT120NS	T42IT100NP	T48BT110NS	T48BT120NS	T48IT100NP
	Filter Accessories REPLFLTR55 UltraClarity Pro® Water Filter	46	59	•	•	•	•	•	•	•	•	•	•	•	•	•	•	•
	NEW MS3000IB10 30" Masterpiece® Handle Kit (Bottom Freezer)	500	549			•												
	NEW PR3000IB10 30" Professional Handle Kit (Bottom Freezer)	500	549			•												
	MS3600IB10 36" Masterpiece® Handle Kit (Bottom Freezer)	549	649						•									
	PR3600IB10 36" Professional Handle Kit (Bottom Freezer)	549	649						•									
	MS3642IT10 36"/42" Masterpiece® Handle Kit (French Door Bottom Freezer)	599	699									•			•			
	PR3642IT10 36"/42" Professional Handle Kit (French Door Bottom Freezer)	599	699									•			•			
	MS4800IT10 48" Masterpiece® Handle Kit (French Door Bottom Freezer)	649	749															•
	PR4800IT10 48" Professional Handle Kit (French Door Bottom Freezer)	649	749															•

The information contained in this document is BSH Home Appliances Corporation's proprietary and confidential information. The release or disclosure of this information without the prior written consent of BSH Home Appliances Corporation is strictly forbidden.

This price list supersedes all previous price lists. Prices listed herein do not include applicable state or local taxes.





Model Number	Description	UMRP	MSRP	T30BB9_5SS	T30IB905SP	T30IB100SP	T36BB110SS	T36BB120SS	T36IB100SP	T36BT110NS	T36BT120NS	T36IT100NP	T42BT110NS	T42BT120NS	T42IT100NP	T48BT110NS	T48BT120NS	T48IT100NP	
	TFL36IB100 36" Stainless Steel Panel Set (Bottom Freezer)	1,099	1,249						•										
	TFL36IT100 36" Stainless Steel Panel Set (French Door Bottom Freezer)	1,149	1,299									•							
	TFL42IT100 42" Stainless Steel Panel Set (French Door Bottom Freezer)	1,199	1,349												•				
	TFL48IT100 48" Stainless Steel Panel Set (French Door Bottom Freezer)	1,249	1,399																•

Freestanding Refrigeration





				T36FT810NS	T36FT820NS
	Filter Accessories REPLFLTR55 Freedom® Replacement Water Filter	46	59	•	•

The information contained in this document is BSH Home Appliances Corporation's proprietary and confidential information. The release or disclosure of this information without the prior written consent of BSH Home Appliances Corporation is strictly forbidden.

This price list supersedes all previous price lists. Prices listed herein do not include applicable state or local taxes.

Model Number	Description	UMRP	MSRP	T24UR905LP	T24UR905RP	T24UR905DP	T24UC925DS	T24UC915DS	T24UC905DP	T24UW905LP	T24UW905RP
 MS20HNDL20	20" Under-Counter Masterpiece® Handle Kit (Set of 2)	300	329			•			•		
 MS22HNDL25	25" Under-Counter Masterpiece® Handle	165	189	•	•					•	•
 PR20HNDL20	20" Under-Counter Professional Handle Kit (Set of 2)	300	329			•			•		
 PR22HNDL25	25" Under-Counter Professional Handle	165	189	•	•					•	•
 UCTRFLTR10	Under-Counter Filter	75	89				•	•	•		

Wine Refrigeration

				T18IW905SP	T24IW905SP
Installation Accessories					
 FRAMEKIT10	Freedom® Frame Kit (For use with any custom column for installation in 24-inch (610 mm) deep cutouts. With two metal side trims whose placement between the interior cutout wall and the appliance helps overcome the challenge of unfinished cabinet returns. Note: Included with all pre-assembled bottom freezers)	105	119		•
 HEATRKIT20	Freedom® Heater Kit (For use when columns are less than 6" apart but not side by side, or for nontraditional side-by-side combinations, without freezer column. This kit is also recommended to be ordered for use with any installation in areas that are subject to high humidity (>65%), or located next to an outside wall.)	599	699	•	•
Interior Accessories for Wine Columns					
 T18WINERK1	18" Wine Shelf providing a 62 bottle capacity. Cannot be used with Presenter Shelf	229	259	•	
 T24WINERK1	24" Wine Shelf providing a 99 bottle capacity. Cannot be used with Presenter Shelf	299	329		•

The information contained in this document is BSH Home Appliances Corporation's proprietary and confidential information. The release or disclosure of this information without the prior written consent of BSH Home Appliances Corporation is strictly forbidden.

COLUMN QUICK REFERENCE GUIDE

This price list supersedes all previous price lists. Prices listed herein do not include applicable state or local taxes.

Quick Reference Guide



Step 1: Columns and Bottom Freezers

Step 2: Panels

Step 3: Handles

Freedom® Column Type	Width	Door Swing Type	Custom Panel	Flat Stainless Steel Panel	Handleless Stainless Steel Panel	Masterpiece®	Professional
REFRIGERATOR COLUMNS							
T24IR905SP	24"	Reversible	Panel Ready	TFL24IR800	TFL24IR905	Order one 36" handle per column Masterpiece® MS36HNDL20	Order one 36" handle per column Professional PR36HNDL20
T30IR905SP	30"	Reversible	Panel Ready	TFL30IR800	TFL30IR905		
T36IR905SP	36"	Reversible	Panel Ready	TFL36IR900	TFL36IR905		
FREEZER COLUMNS							
T18IF905SP	18"	Reversible	Panel Ready	TFL18IR800	TFL18IR905	Order one 36" handle per column Masterpiece® MS36HNDL20	Order one 36" handle per column Professional PR36HNDL20
T24IF905SP	24"	Reversible	Panel Ready	TFL24IR800	TFL24IR905		
T30IF905SP	30"	Reversible	Panel Ready	TFL30IR800	TFL30IR905		
T36IF905SP	36"	Reversible	Panel Ready	TFL36IR900	TFL36IR905		
FREEZER COLUMNS WITH IWD¹							
T18ID905LP	18"	Left	Panel Ready	TFL18ID800	TFL18ID905	Order one 36" handle per column Masterpiece® MS36HNDL20	Order one 36" handle per column Professional PR36HNDL20
T18ID905RP	18"	Right	Panel Ready	TFL18ID800	TFL18ID905		
T24ID905LP	24"	Left	Panel Ready	TFL24ID800	TFL24ID905		
T24ID905RP	24"	Right	Panel Ready	TFL24ID800	TFL24IR905		
BOTTOM FREEZERS/FRENCH DOOR BOTTOM FREEZERS							
T30IB905SP ²	30"	Reversible	Panel Ready	TFL30IB800	TFL30IR905	Order one 30" handle and one 36" handle per column ²	Order one 30" handle and one 36" handle per column ²
WINE REFRIGERATION							
T18IW905SP	18"	Reversible	Panel Ready	TFL18IW800	TFL18IW905	Order one 36" handle per column Masterpiece® MS36HNDL20	Order one 36" handle per column Professional PR36HNDL20
T24IW905SP	24"	Reversible	Panel Ready	TFL24IW800	TFL24IW905		

NOTE: Handleless panels should not be installed on units without the SoftClose® capability. If you are uncertain if you have a refrigeration unit with SoftClose® capability, please contact our customer team by calling 1-800-735-4328.

¹ IWD = Ice and Water Dispenser

² Masterpiece®: (1) MS30HNDL20, (1) MS36HNDL20. Professional: (1) PR30HNDL20, (1) PR36HNDL20

³ Masterpiece®: (2) MS36HNDL20. Professional: (2) PR36HNDL20

⁴ Masterpiece®: (3) MS36HNDL20. Professional: (3) PR36HNDL20





The information contained in this document is BSH Home Appliances Corporation's proprietary and confidential information. The release or disclosure of this information without the prior written consent of BSH Home Appliances Corporation is strictly forbidden.

BUILT-IN COFFEE MACHINE

This price list supersedes all previous price lists. Prices listed herein do not include applicable state or local taxes.

Model Number	Description	UMRP	MSRP
All Built-In Coffee Machines Include the Following Features:			
<ul style="list-style-type: none"> Equipped with the Thermador Connected Experience by Home Connect™ that enables ease of usage, accessibility to wider variety of beverages with the Coffee World and much more Perfect for frequent selections, coffee customization settings store up to 8 personalized beverages with names so family members and house guests can program their favorite drinks—from single shot espresso, to tea, to extra-large cappuccinos Easy to read color TFT display illustrates beverage selection, including size and temperature control 1 lb. Bean container Height-adjustable dispenser with dual spouts for brewing 2 cups at a time Beverages can be adjusted in small increments One Touch Function for coffee and milk/froth Fully automatic rinse program 2-disk grinding units made of high performance ceramic disks Adjustable grinding settings for very fine to coarse Separate drawer for ground coffee, capacity to hold up to two level scoops Built-In water filter Sensor alerts when coffee beans and water level is low 81 oz. water container Includes Insulated 17 oz. removable stainless steel milk container, measuring spoon, water hardness test. 120 Volts. (V) 			

Built-In Coffee Machine

TCM24TS	Thermador Built-In Coffee Machine	4,049	4,499	 TCM24TS 
	<ul style="list-style-type: none"> Includes direct plumb for water and drain connection with AquaStop® Plus protection 			 TCM24PS 
TCM24PS	Thermador Built-In Coffee Machine Plumbed	4,429	4,899	

Accessories

















				TCM24TS	TCM24PS
	TCMTK30RS	30" Stainless Steel Trim Kit	429 479	•	•

For coffee accessories, please see the Cleaners & Accessories Price List.

The information contained in this document is BSH Home Appliances Corporation's proprietary and confidential information. The release or disclosure of this information without the prior written consent of BSH Home Appliances Corporation is strictly forbidden.

Built-in OVENS

MASTERPIECE® & PROFESSIONAL COLLECTIONS

	SINGLE 30"	DOUBLE 30"	COMBO 30"	TRIPLE 30"
<p>DELUXE</p> <p>Rotisserie Max Broil 3 Telescopic Racks (Single Ovens) 4 Telescopic Racks (Double Ovens) 6 Telescopic Racks (Combo Steam Ovens)</p>	 <p>Professional: POD301W POD301LW* POD301RW*</p>  <p>Masterpiece®: MED301WS MED301LWS* MED301RWS*</p>	 <p>Professional: POD302W POD302LW* POD302RW*</p>  <p>Masterpiece®: MED302WS MED302LWS* MED302RWS*</p>	 <p><i>With Steam and Convection Oven:</i></p> <p>Professional: PODS302B*</p> <p>Masterpiece®: MEDS302BS</p>  <p><i>With Speed Oven:</i></p> <p>Professional: PODMC301W*</p> <p>Masterpiece®: MEDMC301WS</p>	 <p><i>With Speed Oven:</i></p> <p>Professional: PODMCW31W*</p> <p>Masterpiece®: MEDMCW31WS</p>
<p>SELECT</p> <p>1 Telescopic Rack (Single Ovens) 2 Telescopic Racks (Double Ovens)</p>	 <p>Professional: PO301W</p>  <p>Masterpiece®: ME301WS</p>	 <p>Professional: PO302W</p>  <p>Masterpiece®: ME302WS</p>	 <p><i>With Microwave:</i></p> <p>Professional: POM301W</p>  <p>Masterpiece®: MEM301WS</p>	<p>SPECIALTY</p> <p>3 Telescopic Racks (Steam Ovens)</p>  <p><i>Steam and Convection Oven:</i></p> <p>Professional: PODS301B</p> <p>Masterpiece®: MEDS301BS</p>  <p><i>Speed Oven:</i></p> <p>Professional: MC30WP</p> <p>Masterpiece®: MC30WS</p>
<p>STANDARD</p> <p>1 Telescopic Rack (Single Ovens) 1 Telescopic Rack (Double Ovens)</p>	 <p>Masterpiece®: ME301YP</p>	 <p>Masterpiece®: ME302YP</p>		

* Not pictured.

The information contained in this document is BSH Home Appliances Corporation's proprietary and confidential information. The release or disclosure of this information without the prior written consent of BSH Home Appliances Corporation is strictly forbidden.

This price list supersedes all previous price lists. Prices listed herein do not include applicable state or local taxes.

Model Number	Description	UMRP	MSRP
--------------	-------------	------	------

All Masterpiece® Series Built-In Ovens Include the Following Features:

- | | | |
|---|--|--|
| <ul style="list-style-type: none"> • Thermador Connected Experience with Home Connect™ • SoftClose® doors | <ul style="list-style-type: none"> • Two-hour self clean • Sabbath Mode • Two halogen lights • Star-K certified • 208–240 V | <p>Microwave/Speed Ovens</p> <ul style="list-style-type: none"> • 1.6 cu. ft. overall capacity • 10 power levels • Sensor cooking • Sensor reheat |
| <p>Cooking Modes</p> <ul style="list-style-type: none"> • True Convection, Bake, Convection Bake, Convection Broil, Convection Roast, Proof, Warm, Pizza, Air Fry capable when connected to Wi-Fi (except ME301YP & ME302YP models) | | |

30" Masterpiece® Ovens

30" Masterpiece® Single Oven with Professional Handle

- One Full Access® telescopic rack and two standard racks
- Silver glass
- 4.6 cu. ft. overall oven capacity

- Three Additional Cooking modes: Variable Broil Hi, Variable Broil Low, Fast Preheat

ME301YP¹ 30" Single Oven, 1 Telescopic Rack

2,899 3,199



ME301YP

30" Masterpiece® Single Oven—Select

- | | | |
|---|---|--|
| <ul style="list-style-type: none"> • One Full Access® telescopic rack and two standard racks • TFT Touch control display • Silver glass on stainless steel | <ul style="list-style-type: none"> • 4.5 cu. ft. overall oven capacity • Five Additional Cooking modes: Speed Convection, Broil, Roast, Dehydrate, Slow Roast | <ul style="list-style-type: none"> • Fast preheat • Meat probe |
|---|---|--|

ME301WS 30" Single Oven, 1 Telescopic Rack

4,699 5,199



ME301WS

30" Masterpiece® Single Oven—Deluxe

- | | | |
|---|---|--|
| <ul style="list-style-type: none"> • Three Full Access® telescopic racks • TFT Touch control display • Silver glass on stainless steel | <ul style="list-style-type: none"> • 4.5 cu. ft. overall oven capacity • Eight Additional Cooking modes: Speed Convection, Rotisserie, Broil, Max Broil, Max Convection Broil, Roast, Dehydrate, Slow Roast | <ul style="list-style-type: none"> • Fast preheat • Commercial-style rotisserie with 12-pound capacity • Multi-point meat probe |
|---|---|--|

MED301WS 30" Single Oven, 3 Telescopic Racks

5,319 5,899

MED301LWS 30" Single Oven, 3 Telescopic Racks, Left Side Opening Door

5,649 6,249

MED301RWS 30" Single Oven, 3 Telescopic Racks, Right Side Opening Door

5,649 6,249



MED301WS



MED301LWS

¹ Is not Air Fry capable.

The information contained in this document is BSH Home Appliances Corporation's proprietary and confidential information. The release or disclosure of this information without the prior written consent of BSH Home Appliances Corporation is strictly forbidden.

This price list supersedes all previous price lists. Prices listed herein do not include applicable state or local taxes.

Model Number	Description	UMRP	MSRP
--------------	-------------	------	------

30" Masterpiece® Ovens

30" Masterpiece® Double Oven with Professional Handle

- One Full Access® telescopic rack (U)
- Silver glass
- 4.6 cu. ft. overall oven capacity (U/L)
- Three Additional Cooking modes: Variable Broil Hi, Variable Broil Low, Fast Preheat (U)
- Six Cooking modes in Lower Oven: Bake, Variable Broil Hi, Variable Broil Low, Roast, Warm, Sabbath, Fast Preheat (L)

ME302YP ¹	30" Double Oven, 1 Telescopic Rack (U)	4,599	5,099
----------------------	--	-------	-------



ME302YP



30" Masterpiece® Double Oven—Select

- Two Full Access® telescopic racks (U/L)
- TFT Touch control display
- Silver glass on stainless steel
- 4.5 cu. ft. overall oven capacity (U/L)
- Five Additional Cooking modes: Speed Convection, Broil, Roast, Dehydrate, Slow Roast (U/L)
- Fast preheat (U/L)
- Meat probe (U/L)

ME302WS	30" Double Oven, 2 Telescopic Racks, Meat probe (U/L)	7,399	8,149
---------	---	-------	-------



ME302WS



¹ Is not Air Fry capable.

The information contained in this document is BSH Home Appliances Corporation's proprietary and confidential information. The release or disclosure of this information without the prior written consent of BSH Home Appliances Corporation is strictly forbidden.

This price list supersedes all previous price lists. Prices listed herein do not include applicable state or local taxes.

Model Number	Description	UMRP	MSRP
--------------	-------------	------	------

30" Masterpiece® Ovens

30" Masterpiece® Double Oven—Deluxe

- Three Full Access® telescopic racks (U); One Full Access® telescopic rack and two standard racks (L)
- TFT Touch control display
- Silver glass on stainless steel
- 4.5 cu. ft. overall oven capacity (U/L)
- Nine Additional Cooking modes: Speed Convection, Broil, Max Broil, Roast, Max Convection Broil, Dehydrate, Slow Roast, Dehydrate, Rotisserie (U)
- Five Additional Cooking modes: Speed Convection, Broil, Roast, Dehydrate, Slow Roast (L)
- Fast preheat
- Commercial-style rotisserie with 12-pound capacity (U)
- Multi-point meat probe (U); Meat probe (L)

MED302WS	30" Double Oven, 4 Telescopic Racks	7,999	8,799
MED302LWS	30" Double Oven, 4 Telescopic Racks, Left Side Opening Door	8,699	9,599
MED302RWS	30" Double Oven, 4 Telescopic Racks, Right Side Opening Door	8,699	9,599



MED302WS



MED302LWS



The information contained in this document is BSH Home Appliances Corporation's proprietary and confidential information. The release or disclosure of this information without the prior written consent of BSH Home Appliances Corporation is strictly forbidden.

This price list supersedes all previous price lists. Prices listed herein do not include applicable state or local taxes.

Model Number	Description	UMRP	MSRP
--------------	-------------	------	------

30" Masterpiece® Ovens

30" Masterpiece® Combination Oven with Microwave

- One Full Access® telescopic rack and two standard racks (L)
- Five Additional Cooking modes: Speed Convection, Broil, Roast, Dehydrate, Slow Roast
- Fast preheat
- Meat probe (L)

Microwave features:

- Touch control display
- 1.6 cu. ft. overall capacity
- 13" turntable
- 950 W microwave power

MEM301WS 30" Combination Oven with Microwave, 1 Telescopic Rack

6,299 6,949



MEM301WS



30" Masterpiece® Combination Oven with Speed Oven

- Three Full Access® telescopic racks (L)
- Eight Additional Cooking modes: Speed Convection, Rotisserie, Broil, Max Broil, Max Convection Broil, Roast, Dehydrate, Slow Roast
- Fast preheat
- Commercial-style rotisserie with 12-pound capacity
- Multi-point meat probe (L)

Speed Oven features:

- 36 Cook Smart™ Programs
- 12 ½" turntable
- 1000 W microwave power

MEDMC301WS 30" Combination Oven with Speed Oven, 3 Telescopic Racks

7,699 8,499



MEDMC301WS



30" Masterpiece® Triple Combination Oven with Speed Oven and Warming Drawer

- Three Full Access® telescopic racks (L)
- Eight Additional Cooking modes: Speed Convection, Rotisserie, Broil, Max Broil, Max Convection Broil, Roast, Dehydrate, Slow Roast
- Fast preheat for seven different cooking modes
- Commercial-style rotisserie with 12-pound capacity
- Multi-point meat probe (L)

Speed Oven features:

- 36 Cook Smart™ Programs
- 12 ½" turntable
- 1000 W microwave power

Warming Drawer features:

- 2.5 cu. ft. overall capacity
- Touch control
- SoftClose® drawer
- 450 W heater
- Four heating modes: Low, Medium, High, Proof
- Timer

MEDMCW31WS 30" Triple Combo Oven with Speed Oven, 3 Telescopic Racks

9,899 10,899



MEDMCW31WS



The information contained in this document is BSH Home Appliances Corporation's proprietary and confidential information. The release or disclosure of this information without the prior written consent of BSH Home Appliances Corporation is strictly forbidden.

This price list supersedes all previous price lists. Prices listed herein do not include applicable state or local taxes.

Model Number	Description	UMRP	MSRP
--------------	-------------	------	------

All Masterpiece® Series Built-in Steam and Convection Ovens Include the Following Features:

- Thermador Connected Experience with Home Connect™
- Large steam cavity 2.8 cu. ft.
- TFT Touch control display
- Silver glass on stainless steel
- SoftClose® doors
- 41 EasyCook® programs
- Features 17 cooking modes: True Convection, Convection Bake, Bake, Convection Roast, Roast, Convection Broil, Broil, Pizza, Speed Convection, Slow Roast, Dehydrate, Proof, Warm, Steam, Steam Convection, Reheat, Defrost, Air Fry capable when connected to Wi-Fi
- Easy Clean program
- Fast preheat for five different cooking modes
- Three Full Access® telescopic rails
- Multi-point meat probe
- 1.4 qt. water tank
- LED lights
- Sabbath Mode
- Star-K certified
- 208-240 volts

Masterpiece® Steam and Convection Ovens

30" Masterpiece® Steam and Convection Oven

MEDS301BS	30" Steam and Convection Oven with 3 Telescopic Racks	5,649	6,249
-----------	---	-------	-------



MEDS301BS



30" Masterpiece® Steam and Convection Oven—Deluxe

- Lower oven: Thermador Connected Experience with Home Connect™
- 4.5 cu. ft. overall oven capacity
- 16 Cooking modes: True Convection, Speed Convection, Rotisserie, Max Broil, Bake, Broil, Roast, Convection Bake, Convection Broil, Max Convection Broil, Convection Roast, Proof, Warm, Pizza, Dehydrate, Slow Roast
- Two-hour self clean
- Fast preheat for seven different cooking modes
- Three Full Access® telescopic racks
- Multi-point meat probe
- Three halogen lights
- Sabbath Mode
- Star-K certified
- 208–240 V

MEDS302BS	30" Deluxe, Steam and Convection Double Oven with 6 Telescopic Racks	9,249	10,199
-----------	--	-------	--------



MEDS302BS



Accessories

				Masterpiece®		
				30" Single Ovens	30" Double Ovens	30" Series Built-in Steam and Convection
	TWO30YS	Side-by-Side Installation Kit for Single Ovens	279	309	•	

The information contained in this document is BSH Home Appliances Corporation's proprietary and confidential information. The release or disclosure of this information without the prior written consent of BSH Home Appliances Corporation is strictly forbidden.

This price list supersedes all previous price lists. Prices listed herein do not include applicable state or local taxes.

Model Number	Description	UMRP	MSRP
--------------	-------------	------	------

All Professional Series Built-In Ovens Include the Following Features:

- Thermador Connected Experience with Home Connect™
 - Restaurant-style stainless steel knobs
 - TFT Touch control display
 - Silver glass on stainless steel
 - SoftClose® doors
 - 4.5 cu. ft. overall oven capacity
 - 13 Cooking modes: True Convection, Speed Convection, Bake, Broil, Roast, Convection Bake, Convection Broil, Convection Roast, Proof, Warm, Pizza, Dehydrate, Slow Roast, Air Fry capable when connected to Wi-Fi
 - Two-hour self clean
 - Fast preheat for seven different cooking modes
 - Two halogen lights
 - Sabbath Mode
 - Star-K certified
 - 208-240 V
- Microwave/Speed Ovens**
- 1.6 cu. ft. overall capacity
 - 10 power levels
 - Sensor cooking
 - Sensor reheat

30" Professional Series Ovens

30" Professional Single Oven—Select

- One Full Access® telescopic rack and two standard racks
- Meat probe

PO301W	30" Single Oven, 1 Telescopic Rack	5,199	5,749
--------	------------------------------------	-------	-------



PO301W



30" Professional Single Oven—Deluxe

- Additional Cooking modes: Rotisserie, Max Broil, Max Convection Broil
- Commercial-style rotisserie with 12-pound capacity
- Three Full Access® telescopic racks
- Multi-point meat probe

POD301W	30" Single Oven, 3 Telescopic Racks	5,799	6,399
POD301LW	30" Single Oven, Left Side Opening Door, 3 Telescopic Racks	6,149	6,799
POD301RW	30" Single Oven, Right Side Opening Door, 3 Telescopic Racks	6,149	6,799



POD301W



POD301LW



The information contained in this document is BSH Home Appliances Corporation's proprietary and confidential information. The release or disclosure of this information without the prior written consent of BSH Home Appliances Corporation is strictly forbidden.

This price list supersedes all previous price lists. Prices listed herein do not include applicable state or local taxes.

Model Number	Description	UMRP	MSRP
--------------	-------------	------	------

30" Professional Series Ovens

30" Professional Double Oven—Select

- One Full Access[®] telescopic rack and two standard racks (U/L)
- Meat probe

PO302W	30" Double Oven, 1 Telescopic Rack (U/L)	7,999	8,799
--------	--	-------	-------



PO302W



30" Professional Double Oven—Deluxe

- Three Full Access[®] telescopic racks (U)
- One Full Access[®] telescopic rack and two standard racks (L)
- Additional Cooking modes: Rotisserie, Max Broil, Max Convection Broil (U)
- Multi-point meat probe(U)
- Meat probe (L)

POD302W	30" Double Oven, 4 Telescopic Racks	8,749	9,649
POD302LW	30" Double Oven, 4 Telescopic Racks, Left Side Opening Door	9,399	10,349
POD302RW	30" Double Oven, 4 Telescopic Racks, Right Side Opening Door	9,399	10,349



POD302W



POD302LW



The information contained in this document is BSH Home Appliances Corporation's proprietary and confidential information. The release or disclosure of this information without the prior written consent of BSH Home Appliances Corporation is strictly forbidden.

This price list supersedes all previous price lists. Prices listed herein do not include applicable state or local taxes.

Model Number	Description	UMRP	MSRP
--------------	-------------	------	------

30" Professional Series Ovens

30" Professional Combination Oven with Microwave

- One Full Access[®] telescopic rack and two standard racks (L)
- Meat probe (L)
- Microwave features:
 - Touch control display
 - 13" turntable
- 950 W microwave power

POM301W	30" Combination Oven with Microwave, 1 Telescopic Rack	6,999	7,699
---------	--	-------	-------



POM301W



30" Professional Combination Oven with Speed Oven

- Additional Cooking modes:
 - Rotisserie, Max Broil, Max Convection Broil
- Three Full Access[®] telescopic racks
- Multi-point meat probe
- Speed Oven features:
 - 36 Cook Smart[™] Programs
 - 12 1/2" turntable
 - 1,000 W microwave power

PODMC301W	30" Combination Oven with Speed Oven, 3 Telescopic Racks	8,449	9,299
-----------	--	-------	-------



PODMC301W



The information contained in this document is BSH Home Appliances Corporation's proprietary and confidential information. The release or disclosure of this information without the prior written consent of BSH Home Appliances Corporation is strictly forbidden.

This price list supersedes all previous price lists. Prices listed herein do not include applicable state or local taxes.

Model Number	Description	UMRP	MSRP
--------------	-------------	------	------

30" Professional Series Ovens

30" Professional Triple Combination Oven with Speed Oven and Warming Drawer

- | | | |
|--|--|--|
| <ul style="list-style-type: none"> • Additional Cooking modes: Rotisserie, Max Broil, Max Convection Broil • Three Full Access® telescopic racks • Multi-point meat probe | <p>Speed Oven features:</p> <ul style="list-style-type: none"> • 36 Cook Smart™ Programs • 12 ½" turntable • 1,000 W microwave power | <p>Warming Drawer features:</p> <ul style="list-style-type: none"> • SoftClose® drawer • Touch control • 2.5 cu. ft. overall capacity • 450 W heater • Four heating modes: Low, Medium, High, Proof • Timer |
|--|--|--|



PODMCW31W

PODMCW31W	30" Triple Combo Oven with Speed Oven, 3 Telescopic Racks	10,599	11,699
-----------	---	--------	--------



The information contained in this document is BSH Home Appliances Corporation's proprietary and confidential information. The release or disclosure of this information without the prior written consent of BSH Home Appliances Corporation is strictly forbidden.

This price list supersedes all previous price lists. Prices listed herein do not include applicable state or local taxes.

Model Number	Description	UMRP	MSRP
--------------	-------------	------	------

All Professional Series Built-in Steam and Convection Ovens Include the Following Features:

- Thermador Connected Experience with Home Connect™
- Large steam cavity 2.8 cu. ft.
- TFT Touch control display
- Restaurant-style stainless steel knobs
- Silver glass on stainless steel
- SoftClose® doors
- 41 EasyCook® programs
- Features 17 cooking modes: True Convection, Convection Bake, Bake, Convection Roast, Roast, Convection Broil, Broil, Pizza, Speed Convection, Slow Roast, Dehydrate, Proof, Warm, Steam, Steam Convection, Reheat, Defrost
- Steam Clean program
- Fast preheat for five different cooking modes
- Three Full Access® telescopic rails
- Multi-point meat probe
- 1.4 qt. water tank
- LED lights
- Sabbath Mode
- Star-K certified
- 208-240 V

30" Professional Series Built-In Steam and Convection Oven

Professional Series Steam and Convection Oven

PODS301B	30" Steam and Convection Oven with 3 Telescopic Racks	6,049	6,699
----------	---	-------	-------



PODS301B



Professional Combination Oven with Steam and Convection Oven—Deluxe

- Lower oven: Thermador Connected Experience with Home Connect™
- 4.5 cu. ft. overall oven capacity
- 16 Cooking modes: True Convection, Speed Convection, Rotisserie, Max Broil, Bake, Broil, Roast,
- Convection Bake, Convection Broil, Max Convection Broil, Convection Roast, Proof, Warm, Pizza, Dehydrate, Slow Roast
- Two-hour self clean
- Fast preheat for seven different cooking modes
- Three Full Access® telescopic racks
- Multi-point meat probe
- Three halogen lights
- Sabbath Mode
- Star-K certified
- 208-240 V

PODS302B	30" Deluxe, Steam and Convection Double Oven with 6 Telescopic Racks	9,799	10,799
----------	--	-------	--------



PODS302B



1 To be fully ADA compliant, these units must be installed according to ADA guidelines. Please check current ADA requirements for guidance on installation.

The information contained in this document is BSH Home Appliances Corporation's proprietary and confidential information. The release or disclosure of this information without the prior written consent of BSH Home Appliances Corporation is strictly forbidden.

This price list supersedes all previous price lists. Prices listed herein do not include applicable state or local taxes.

Model Number	Description	UMRP	MSRP
--------------	-------------	------	------

All Masterpiece® Series Microwaves Include the Following Features:

- Silver glass on stainless steel
- 10 power levels
- Sensor reheat

Built-In Microwaves

Built-In Microwaves

- Touch Control Display
- 1.6 cu. ft. overall capacity
- 14 1/8" ceramic turntable
- 950 W Microwave power
- Plugs into 120 V, 60 Hz/, AC 3-prong grounded outlet

MB30WS	30" Masterpiece® Microwave, Stainless Steel, 120 V	2,349	2,599
MB30WP	30" Professional Microwave, Stainless Steel, 120 V	2,549	2,849



MB30WS



MB30WP



24" Built-in Microwave with side swing door and trim kit accessory in 30"

- Glass touch controls with white display
- 2.1 cu. Ft. overall capacity
- 16 1/2" Glass Turntable
- Microwave Power 1,200 W
- Sensor Cooking

MBCS	24" Masterpiece® Microwave, Side Swing Door Stainless Steel	899	999
MBT30CS	30" Thermador Trim Kit, Standard Microwave, Stainless Steel	349	389



MBCS w/ MBT30CS

MicroDrawer® Microwaves

Built-In MicroDrawer® Microwaves

- New hidden control panel; opens for enhanced visibility
- Home Connect® allows for remote monitoring and control the drawer microwave with Wi-Fi Connectivity
- 1.2 cu. Ft. overall capacity
- Microwave Power 950 W
- Sensor Cooking Door
- Opens and Closes through Touch Control
- Can Be Installed Flush

MD24BS	24" MicroDrawer Microwave	2,199	2,449
MD30BS	30" MicroDrawer Microwave	2,249	2,499



MD24BS



MD30BS

¹ To be fully ADA compliant, these units must be installed according to ADA guidelines. Please check current ADA requirements for guidance on installation.

The information contained in this document is BSH Home Appliances Corporation's proprietary and confidential information. The release or disclosure of this information without the prior written consent of BSH Home Appliances Corporation is strictly forbidden.

This price list supersedes all previous price lists. Prices listed herein do not include applicable state or local taxes.

Model Number	Description	UMRP	MSRP
--------------	-------------	------	------

Over-the-Range Microwave

Over-the-Range Microwave

- Design match for use in combination with 30" Pro Harmony® 5-burner gas range
- Exclusive stainless steel handle
- LCD display
- 2.1 cu. ft. cavity
- 14 3/16" glass turntable
- 1,100 W microwave power
- Triple microwave distribution system
- 10 cooking modes
- Sensor cooking
- Plugs into standard 120 V, 3-prong outlet
- Four-speed vent with up to 385 CFM



MU30WSU

MU30WSU	Over-the-Range Microwave, Stainless Steel	1,149	1,299
---------	---	-------	-------

Speed Ovens

Built-In Speed Ovens

- Silver glass on stainless steel
- Full color TFT display
- 12 3/4" ceramic turntable
- 1.6 cu. ft. overall capacity
- 36 Cook Smart™ Programs
- 10 power levels
- 1,000 W Microwave power
- Sensor cooking
- Sensor reheat
- Convection Bake
- Broil
- 208 or 240 V, 4 wire fixed connection



MC30WS

MC30WS	30" Masterpiece® Speed Oven, Stainless Steel, 208-240 V	2,999	3,299
--------	---	-------	-------

MC30WP	30" Professional Speed Oven, Stainless Steel, 208-240 V	3,249	3,599
--------	---	-------	-------



MC30WP



The information contained in this document is BSH Home Appliances Corporation's proprietary and confidential information. The release or disclosure of this information without the prior written consent of BSH Home Appliances Corporation is strictly forbidden.

WARMING DRAWERS/ACCESSORIES

This price list supersedes all previous price lists. Prices listed herein do not include applicable state or local taxes.

Model Number	Description	UMRP	MSRP
--------------	-------------	------	------

Warming Drawers

Standard Warming Drawers

- Our warming drawer is the perfect combination of uncompromising performance, unique convenience features and elegant design

- SoftClose® door (WD30W only)
- 2.2 cu. ft. overall capacity
- Touch Control Display
- Four heating modes: Low,

Medium, High, Proof

- 450 W heating element
- Timer
- Plugs into a standard 120 volt, 3-prong outlet



WD30WC

WD30W	30" Warming Drawer, Custom Panel Ready	2,199	2,449
WD30WC	30" Warming Drawer, Push to Open	1,999	2,199

Storage Drawers

- Our storage drawers are the perfect combination of uncompromising performance, unique convenience features and elegant design

- 2.4 or 0.8 cu. ft. overall capacity





SD30WC



SDS30WC

SD30WC	30" Storage Drawer (2.4 cu. ft.)	1,099	1,249
SDS30WC	30" Storage Drawer, Short Height (0.8 cu. ft.) (Install Under Steam Oven)	1,049	1,199

Accessories

Image	Number	Description	UMRP	MSRP	Professional Series											
					PO301W	POD301W	POD301LW	POD301RW	PO302W	POD302W	POD302LW	POD302RW	POM301W	PDMC301W	PDMCW31W	PODS301B
	WKNOBKT3W	Blue Metal Knob Kit for Professional Oven (2 pc.)	49	59	•	•	•	•	•	•	•	•	•	•	•	•
	TWO30YS	Side-by-Side Installation Kit for Single Ovens	279	309	•	•	•	•								•

The information contained in this document is BSH Home Appliances Corporation's proprietary and confidential information. The release or disclosure of this information without the prior written consent of BSH Home Appliances Corporation is strictly forbidden.

This price list supersedes all previous price lists. Prices listed herein do not include applicable state or local taxes.

Model Number	Description	UMRP	MSRP
--------------	-------------	------	------

All Masterpiece® Series Star® Burner Gas Cooktops Include the Following Features:

- Patented Star® Burner provides superior flame coverage for faster and more even pan heating
- 16K BTU max
- Blue indicator burner ON light
- Chiseled stainless steel design
- Stainless steel control panel offers a sleek, modern design
- High-quality, robust, metal knobs
- LP gas conversion kit not included; order separately
- Sabbath compliant
- Two-year warranty

Masterpiece® Series

LR: BTU 10,000 high/1,750 low	C: BTU 16,000 high/1,900 low	RR: BTU 8,000 high/1,750 low	
LF: BTU 8,000 high/1,750 low		RF: BTU 10,000 high/1,750 low	
SGS305TS	30" Star® Burner, Stainless Steel, Five Burners	1,699	1,899

- ExtraLow® Select feature, which provides 204 BTU low simmering capability with five precise setting cycles

LR: BTU 10,000 high/1,750 low	C: BTU 16,000 high/583 XLO	RR: BTU 8,000 high/1,750 low	
LF: BTU 8,000 high/204 XLO		RF: BTU 10,000 high/1,750 low	
SGSX305TS	30" Star® Burner, Stainless Steel, Five Burners, ExtraLow® Select	2,199	2,449

LR: BTU 12,000 high/1,750 low	C: BTU 16,000 high/1,900 low	RR: BTU 9,100 high/1,750 low	
LF: BTU 9,100 high/1,750 low		RF: BTU 12,000 high/1,750 low	
SGS365TS	36" Star® Burner, Stainless Steel, Five Burners	1,999	2,199

- ExtraLow® Select feature, which provides 204 BTU low simmering capability with five precise setting cycles

LR: BTU 12,000 high/1,750 low	C: BTU 16,000 high/583 XLO	RR: BTU 9,100 high/1,750 low	
LF: BTU 9,100 high/204 XLO		RF: BTU 12,000 high/1,750 low	
SGSX365TS	36" Star® Burner, Stainless Steel, Five Burners, ExtraLow® Select	2,399	2,649

The information contained in this document is BSH Home Appliances Corporation's proprietary and confidential information. The release or disclosure of this information without the prior written consent of BSH Home Appliances Corporation is strictly forbidden.

This price list supersedes all previous price lists. Prices listed herein do not include applicable state or local taxes.

Model Number	Description	UMRP	MSRP
--------------	-------------	------	------

All Masterpiece® Series Pedestal Star® Burner Gas Cooktops Include the Following Features:

- Raised Pedestal Star® Burner provides superior flame coverage and allows for easier cleanup under each burner
- 18K BTU max
- QuickClean Base® contains liquid spills
- Sleek glass control panel
- High-quality, robust, metal knobs
- LP conversion kit not included; order separately
- Sabbath compliant
- Two-year warranty

Masterpiece® Series

- Blue indicator light for each burner

LR: BTU 10,000 high/1,750 low	C: BTU 18,000 high/1,900 low	RR: BTU 8,000 high/1,750 low
LF: BTU 8,000 high/1,750 low		RF: BTU 10,000 high/1,750 low



SGSP305TS

SGSP305TS	30" Pedestal Star® Burner, Stainless Steel, Five Burners	2,199	2,449
------------------	--	-------	-------

- Progressive Illuminated light ring around each knob
- ExtraLow® Select feature, which provides 204 BTU low simmering capability with five precise setting cycles

LR: BTU 10,000 high/1,750 low	C: BTU 18,000 high/583 XLO	RR: BTU 8,000 high/1,750 low
LF: BTU 8,000 high/204 XLO		RF: BTU 10,000 high/1,750 low



SGSXP305TS

SGSXP305TS	30" Pedestal Star® Burner, Stainless Steel, Five Burners, ExtraLow® Select	2,599	2,899
-------------------	--	-------	-------

- Blue indicator light for each burner

LR: BTU 12,000 high/1,750 low	C: BTU 18,000 high/1,900 low	RR: BTU 9,100 high/1,750 low
LF: BTU 9,100 high/1,750 low		RF: BTU 12,000 high/1,750 low



SGSP365TS

SGSP365TS	36" Pedestal Star® Burner, Stainless Steel, Five Burners	2,399	2,649
------------------	--	-------	-------

- Progressive Illuminated light ring around each knob
- ExtraLow® Select feature, which provides 204 BTU low simmering capability with five precise setting cycles

LR: BTU 12,000 high/1,750 low	C: BTU 18,000 high/583 XLO	RR: BTU 9,100 high/1,750 low
LF: BTU 9,100 high/204 XLO		RF: BTU 12,000 high/1,750 low



SGSXP365TS

SGSXP365TS	36" Pedestal Star® Burner, Stainless Steel, Five Burners, ExtraLow® Select	2,999	3,299
-------------------	--	-------	-------

The information contained in this document is BSH Home Appliances Corporation's proprietary and confidential information. The release or disclosure of this information without the prior written consent of BSH Home Appliances Corporation is strictly forbidden.

GLASS CERAMIC INDUCTION COOKTOPS

This price list supersedes all previous price lists. Prices listed herein do not include applicable state or local taxes.

Model Number	Description	UMRP	MSRP
--------------	-------------	------	------

All Masterpiece® Series Freedom® and Liberty® Induction Cooktops Include the Following Features:

- PowerBoost®
- 17 power levels
- Home Connect™

Masterpiece® Series

Freedom® Induction – 13" x 21" Cooking Position with 5,500 W

- Entire surface of the cooktop can be used as one large cooking area
- Up to 6 pots or pans are automatically recognized in any position and controlled using a full color touch screen
- Wi-Fi connectivity allows the cooktop and matching hood to communicate with one another to synchronize turning on task light and ventilation fan
- MyZone® mode allows changing a preset power level simply by moving a pot or pan on the cooktop
- Cooking Sensor Mode ready (wireless cooking sensor sold separately)
- Sapphire Glow® LED embedded surface lights along sides of cooktop provide visual feedback when a pot is moved or whether a pot is heated or not (36" models only)
- TeppanyakiPro® mode divides a teppanyaki griddle into one heated and one non-heated area
- PowerBoost®
- 17 power levels
- Residual heat indicators
- Panel Lock
- Cooking Timer, Kitchen Timer and Stopwatch Timer
- Power/Amps: 208/240 V, 60 Hz, 30 A

Minimum cookware size: 3" x 3"
 Maximum cookware size: 13" x 21"
 Performance:
 3,500 W/5,500 W (PowerBoost®)



CIT30YWBB

CIT36YWB

CIT36YWBB



CIT30YWBB	30" Dark Gray Glass, Frameless Design	5,399	5,949
CIT36YWB	36" Dark Gray Glass, Stainless Steel Frame	6,199	6,849
CIT36YWBB	36" Dark Gray Glass, Frameless Design	6,199	6,849

The information contained in this document is BSH Home Appliances Corporation's proprietary and confidential information. The release or disclosure of this information without the prior written consent of BSH Home Appliances Corporation is strictly forbidden.

GLASS CERAMIC INDUCTION COOKTOPS

This price list supersedes all previous price lists. Prices listed herein do not include applicable state or local taxes.

Model Number	Description	UMRP	MSRP
--------------	-------------	------	------

Masterpiece® Series

30" Liberty® Induction

- Two large flexible cooking surfaces allow for tailored cooking zones
- Cooktop-Hood Sync
- Automatic pan recognition
- HeatShift® has three preset heat zones
- MoveMode® allows easy transfer settings
- Illuminated touch controls
- Control panel lock
- Automatic switch off
- Maximum wattage: 7,200 W
- Power/Amps: 208–240 V, 60 Hz/50 A



CIT30FBG



Left Full Zone 15" x 8½" @ 3,300 W/3,600 W (PowerBoost®)	LR: 7½" x 8½" @ 2,200 W/3,600 W (PowerBoost®)	RR: 7½" x 8½" @ 2,200 W/3,600 W (PowerBoost®)	Right Full Zone 15" x 8½" @ 3,300 W/3,600 W (PowerBoost®)
	LF: 7½" x 8½" @ 2,200 W/3,600 W (PowerBoost®)	RF: 7½" x 8½" @ 2,200 W/3,600 W (PowerBoost®)	
	Left FlexPlus Zone 3 ⅝" x 11 ¼"	Right FlexPlus Zone 3 ⅝" x 11 ¼"	

NEW CIT30FBG	30" Titanium Gray Glass, Frameless	3,999	4,399
---------------------	------------------------------------	-------	-------

Available April

36" Liberty® Induction

- Three extra-large Liberty® cooking surfaces allow for tailored cooking zones
- Number of cooking zones: Five
- Cooktop-Hood Sync
- Automatic pan recognition
- HeatShift® has three preset heat zones
- MoveMode® allows easy transfer settings
- Illuminated touch controls
- Control panel lock
- Automatic switch off
- Timer for all zones
- Maximum wattage: 10,800 W
- Power/Amps: 208–240 V, 60 Hz/50 A



CIT367YG



Left Full Zone 15" x 9" @ 3,300 W/3,700 W (PowerBoost®)	LR: 7½" x 9" @ 2,200 W/3,600 W (PowerBoost®)	Center Full Zone 11¼" x 9½" @ 3,300 W/3,600 W (PowerBoost®)	RR: 7½" x 9" @ 2,200 W/3,600 W (PowerBoost®)	Right Full Zone 15" x 9" @ 3,300 W/3,700 W (PowerBoost®)
	LF: 7½" x 9" @ 2,200 W/3,600 W (PowerBoost®)		RF: 7½" x 9" @ 2,200 W/3,600 W (PowerBoost®)	



CIT367YGS



CIT367YG	36" Titanium Gray Glass, Frameless	4,549	5,049
CIT367YGS	36" Titanium Gray Glass, Stainless Steel Frame	4,549	5,049

Discontinues March

CIT367YM	36" Silver Mirrored Glass, Frameless	5,099	5,649
CIT367YMS	36" Silver Mirrored Glass, Stainless Steel Frame	5,049	5,599

Both discontinue March



CIT367YM



CIT367YMS

The information contained in this document is BSH Home Appliances Corporation's proprietary and confidential information. The release or disclosure of this information without the prior written consent of BSH Home Appliances Corporation is strictly forbidden.

GLASS CERAMIC INDUCTION COOKTOPS

This price list supersedes all previous price lists. Prices listed herein do not include applicable state or local taxes.

Model Number	Description	UMRP	MSRP
--------------	-------------	------	------

All Masterpiece® Heritage Series Glass Ceramic Induction Cooktops Include the Following Features:

- Pan Recognition
- Touch control panel with blue light illumination offers 17 power settings
- Speed Heating—induction cooktops heat 50% faster than traditional gas cooktops
- PowerBoost®
- Anti-Overflow System
- Two-Level Heat Indicator
- Kitchen timer
- Child safety lock

Masterpiece® Series

Heritage 11" Element with 3,700 W

- Large and powerful 11" element with 3,700 W
- Power/Amps: 240 V, 60 Hz/30 A

LR: 9" @ 2,200 W/3,700 W (PowerBoost®)	RR: 11" @ 2,600 W/3,700 W (PowerBoost®)
LF: 6" @ 1,400 W/2,200 W (PowerBoost®)	RF: 6" @ 1,400 W/2,200 W (PowerBoost®)



CIT304YB

CIT304YB 30" Frameless Design 3,299 3,649

CIT304YM 30" Silver Mirrored Finish 3,699 4,099



CIT304YM

Both Discontinue March

- Large and powerful 11" element with 3,600 W
- Touch control panel with white light illumination offers 17 power settings
- CookSmart
- Power/Amps: 240 V, 60 Hz/30 A
- Home Connect™

LR: 9" @ 2,200 W/3,600 W (PowerBoost®)	RR: 11" @ 2,600 W/3,600 W (PowerBoost®)
LF: 6" @ 1,400 W/2,200 W (PowerBoost®)	RF: 6" @ 1,400 W/2,200 W (PowerBoost®)



CIT304BB

NEW CIT304BB 30" Black Glass, Frameless Design 3,249 3,599

Available April



Heritage 13" Element with 5,500 W

- Large 13" round heating element
- Triple zone—accommodates multiple-size pans with three diameter sizes
- Power/Amps: 240 V, 60 Hz/50 A

LR: 7" @ 1,800 W/3,100 W (PowerBoost®)	C: 9"/11"/13" @ 2,200 W/3,700 W (PowerBoost®) 2,600 W/4,400 W (PowerBoost®) 3,300 W/5,500 W (PowerBoost®)	RR: 6" @ 1,400 W/2,200 W (PowerBoost®)
LF: 7" @ 1,800 W/3,100 W (PowerBoost®)		RF: 9" @ 2,200 W/3,700 W (PowerBoost®)



CIT365YB



CIT365YB 36" Frameless Design 3,799 4,199

Discontinues March

The information contained in this document is BSH Home Appliances Corporation's proprietary and confidential information. The release or disclosure of this information without the prior written consent of BSH Home Appliances Corporation is strictly forbidden.

GLASS CERAMIC INDUCTION COOKTOPS/GLASS CERAMIC ELECTRIC COOKTOPS

This price list supersedes all previous price lists. Prices listed herein do not include applicable state or local taxes.

Model Number	Description	UMRP	MSRP
<ul style="list-style-type: none"> • Large 13" round heating element • Triple zone—accommodates multiple-size pans with three diameter sizes 	<ul style="list-style-type: none"> • Touch control panel with white light illumination offers 17 power settings • CookSmart 	<ul style="list-style-type: none"> • Power/Amps: 240 V, 60 Hz//50 A • Home Connect™ 	 <p>CIT365BB</p> 
LR: 7" @ 1,800 W/3,100 W (PowerBoost®)	C: 9"/11"/13" @ 2,200 W/3,600 W (PowerBoost®) 2,600 W/3,600 W (PowerBoost®) 3,300 W/3,600 W (PowerBoost®)	RR: 6" @ 1,400 W/2,200 W (PowerBoost®)	
LF: 7" @ 1,800 W/3,100 W (PowerBoost®)		RF: 9" @ 2,200 W/3,600 W (PowerBoost®)	
NEW CIT365BB	36" Black Glass, Frameless Design	3,749	4,149

Available April

All Masterpiece® Series Glass Ceramic Electric Cooktops Include the Following Features:

- Triple element
- Maximum wattage: 4,000 W

Masterpiece® Series

Touch Control

- With the help of CookSmart®, the temperature is reached and maintained automatically without boilover
- Touch controls with blue illumination are easy to use and offer a sleek, modern design
- Keep Warm
- Child Lock
- Shut-Off Timer for every element (current models only)
- Kitchen timer
- Number of cooking zones: Eight
- Power/Amps: 208–240 V, 60 Hz/40/30 A



CET305YB

LR: 5"/7" @ 700 W (1,700 W)	RR: 6"/8"/11" @ 1,050 W/2,200 W/3,080 W		
LF: 6" @ 1,700 W (4,000 W Bridge)	RF: 6" @ 1,200 W		
CET305YB	30" Frameless Design	2,049	2,299

Touch Control/Bridge

- With the help of CookSmart®, the temperature is reached and maintained automatically without boilover
- Bridge element with dual element
- Touch controls with blue illumination are easy to use and offer a sleek, modern design
- PowerBoost®
- Child Lock
- Kitchen timer
- Number of cooking zones: 10
- Power/Amps: 208–240 V, 60 Hz//40/50 A









CET366YB

LR: 5"/7" @ 700 W/1,700 W	C: 6"/8"/11" @ 1,050 W/2,200 W/3,080 W	RR: 6" @ 1,200 W	
LF: 7" @ 1,700 W (4,000 W Bridge)		RF: 6"/8" @ 1,200 W/2,100 W	
CET366YB	36" Stainless Steel Frame	2,399	2,649

The information contained in this document is BSH Home Appliances Corporation's proprietary and confidential information. The release or disclosure of this information without the prior written consent of BSH Home Appliances Corporation is strictly forbidden.

This price list supersedes all previous price lists. Prices listed herein do not include applicable state or local taxes.



















Model Number	Description	UMRP	MSRP	Gas Cooktops Star Burner®	Gas Cooktops Pedestal Star®	Electric Cooktops	Freedom® Induction Liberty® Induction	Heritage Induction
 TEPPAN1321	13" x 21" Recommended accessory for Freedom® Induction Cooktop	499	549				•	
 SGRIDDLEW	Cast Aluminum Griddle Plate <ul style="list-style-type: none"> Fits 30" and 36" 5-burner Star® and Pedestal Star® Burner Series models Locks into the center grate Cast aluminum design allows for even heat distribution and fast preheating Non-stick coating for easy cleanup and cooking Griddle	209	229	• ¹	• ¹			
 TCOOKSENSW	Wireless Cooking Temperature Sensor Allows you to select the best way to prepare every food as you wish. The cooking sensor measures the temperature of the pot continuously. This allows the power to be maintained with greater precision to provide exceptional cooking results. The sensor is required to use the Freedom® induction Cooking Sensor mode Wireless Cooking Sensor	199	219				•	
 SKNOBLUW	Blue Knob Kit, Pedestal Star® Burner Cooktops Fits 30" and 36" Pedestal Star® Burners Series models • Set of five knobs • Blue metallic finish • Easy to install	109	119		•			
 SLPKITW	LP Gas Conversion Kit for Star® Burner Series Cooktops	99	109	•				
 SNPKITPEDW	LP Gas Conversion Kit for Pedestal Star® Burner Series Cooktops	99	109		•			
 SWOKRINGW	Wok Ring Optimized for operation on Star® Burner and Pedestal Star® Burner Series cook with up to a 16" wok • Cast iron construction is durable and dishwasher safe	99	109	•	•			

¹ Fits 30" and 36" 5-burner Star® and Pedestal Star® Burner Series models

The information contained in this document is BSH Home Appliances Corporation's proprietary and confidential information. The release or disclosure of this information without the prior written consent of BSH Home Appliances Corporation is strictly forbidden.

RANGES

PROFESSIONAL COLLECTION

		30"	36"	48"	60"
DUAL-FUEL WITH STEAM RANGES	Pro Grand®			 PRD48WISGU Induction PRD48WDSGU Griddle	 PRD606WESG Griddle
	Pro Harmony®	 PRI30LBHU Induction	 PRI36LBHU Induction		
DUAL-FUEL RANGES	Pro Harmony®	 PRD305WHU 5-burner PRD304WHU 4-burner	 PRD366WHU 6-burner PRD364WDHU Griddle	 PRD486WDHU Griddle	
	Pro Grand®		 PRD366WGU 6-burner PRD364WIGU Induction PRD364WDGU Griddle	 PRD486WIGU Induction PRD486WDGU Griddle	 PRD606WEG Griddle
GAS RANGES	Pro Harmony®	 PRG305WH 5-burner PRG304WH 4-burner	 PRG366WH 6-burner PRG364WDH Griddle	 PRG486WDH Griddle	
	Pro Grand®		 PRG366WG 6-burner	 PRG486WDG Griddle	
RANGE-TOPS	Professional	 PCG305W 5-burner	 PCG366W 6-burner PCG364WD Griddle	 PCG486WD Griddle	

PROFESSIONAL RANGETOPS

This price list supersedes all previous price lists. Prices listed herein do not include applicable state or local taxes.

Model Number	Description	UMRP	MSRP
--------------	-------------	------	------

All Professional Series Rangetops Include the Following Features:

- Continuous porcelain, easy-to-clean cooking surface
- Patented Pedestal Star® Burner with QuickClean Base™
- Each burner has electronic ignition/re-ignition;
- Metal knobs (also available in Metallic Blue, PAKNOBLUWR, sold separately. See page 5-10)
- LED downlighting illuminates the control panel.
- Precision simmering capabilities with two ExtraLow® simmer burners
- Two-year warranty
- Star-K certified
- 15 Amps

Note

- It is strongly recommended that this appliance be installed in conjunction with a Thermador vent hood. (see Thermador Professional Hoods, page 6-5)
- Liquid Propane conversion: Natural to LP Gas Field Conversion Kit must be ordered separately (PALPKITHW for all four- and six-burner units; PALPKITHW5 for five Pedestal Star® Burner units). PAALTKITH High Altitude conversion kit is available for all rangetops.

30" Professional Gas Rangetop

- Five Pedestal Star® Burners (Two with ExtraLow®). overall output of 59,000 BTU.
- Suitable for use with Thermador OTR (see page 3-13)
- 15 Amps



PCG305W



LR: BTU 8,000 high*/XLO	Center: BTU 10,000 high*	RR: BTU 8,000 high*
LF: BTU 18,000 high*/XLO		RF: BTU 15,000 high*

PCG305W	30" Stainless Steel with Porcelain Surface	3,899	4,299
---------	--	-------	-------

36" Professional Gas Rangetop

- Six Pedestal Star® Burners (Two with ExtraLow®).
- 15 Amps



PCG366W



LR: BTU 15,000 high*/XLO	CR: BTU 15,000 high*/3,000 low	RR: BTU 15,000 high*/3,000 low
LF: BTU 18,000 high*/XLO	CF: BTU 18,000 high*/3,000 low	RF: BTU 18,000 high*/3,000 low

PCG366W	36" Stainless Steel with Porcelain Surface	4,549	5,049
---------	--	-------	-------

* 8,000 BTU NG burners convert to 6,000 BTU LP; 10,000 BTU NG burners convert to 9,100 BTU LP; 15,000 BTU NG burners convert to 12,000 BTU LP; 18,000 BTU NG convert to 15,000 BTU LP; 22,000 BTU NG convert to 18,000 BTU LP

NOTE: Models PCG305xx, PRD305xx, PRD606xx, PRG305xx, PRG304xx, PRD304xx, PRx488xx, PRlxxxxx are suitable for 0" rear clearance to combustible surfaces. All other models: when using the included Island Trim a minimum 6" (152 mm) rear clearance is required to a combustible surface. When installing against a combustible surface, a Thermador Low Backguard is required for a 0" rear clearance to the combustible surface. A Thermador Low Backguard must be purchased separately. A rear clearance to a surface covered in a noncombustible material (metal, ceramic tile, brick, marble, or stone) is 0" when using the included Island Trim. Clearances of less than 6" (152 mm) should be approved by the local codes and/or by the local authority having jurisdiction. Clearances from non-combustible materials are not part of the ANSI Z21.1 scope and are not certified by CSA.

The information contained in this document is BSH Home Appliances Corporation's proprietary and confidential information. The release or disclosure of this information without the prior written consent of BSH Home Appliances Corporation is strictly forbidden.

PROFESSIONAL RANGETOPS

This price list supersedes all previous price lists. Prices listed herein do not include applicable state or local taxes.

Model Number	Description	UMRP	MSRP
--------------	-------------	------	------

36" Professional Gas Rangetop

- Four Pedestal Star® Burners (Two with ExtraLow®)
- Non-stick surface Electric Griddle, convertible to Grill with optional accessory PA12GRILLW or PA12GRILFW.
- 20 Amps



LR: BTU 15,000 high*/XLO	Electric Griddle 1,630 W	RR: BTU 15,000 high*/3,000 low
LF: BTU 18,000 high*/XLO		RF: BTU 18,000 high*/3,000 low

PCG364WD	36" Stainless Steel with Porcelain Surface and Griddle	4,599	5,099
----------	--	-------	-------

48" Professional Gas Rangetop

- Six Pedestal Star® Burners (Two with ExtraLow®)
- Non-stick surface Electric Griddle, convertible to Grill with optional accessory PA12GRILLW or PA12GRILFW.
- 20 Amps



PCG486WD



LR: BTU 15,000 high*/XLO	CR: BTU 15,000 high*/3,000 low	Electric Griddle 1,630 W	RR: BTU 15,000 high*/3,000 low
LF: BTU 18,000 high*/XLO	CF: BTU 18,000 high*/3,000 low		RF: BTU 18,000 high*/3,000 low

PCG486WD	48" Stainless Steel with Porcelain Surface and Griddle	5,549	6,149
----------	--	-------	-------

* 8,000 BTU NG burners convert to 6,000 BTU LP; 15,000 BTU NG burners convert to 12,000 BTU LP; 18,000 BTU NG convert to 15,000 BTU LP; 22,000 BTU NG convert to 18,000 BTU LP

NOTE: Models PCG305xx, PRD305xx, PRD606xx, PRG305xx, PRG304xx, PRD304xx, PRx488xx, PRlxxxxxx are suitable for 0" rear clearance to combustible surfaces. All other models: when using the included Island Trim a minimum 6" (152 mm) rear clearance is required to a combustible surface. When installing against a combustible surface, a Thermador Low Backguard is required for a 0" rear clearance to the combustible surface. A Thermador Low Backguard must be purchased separately. A rear clearance to a surface covered in a noncombustible material (metal, ceramic tile, brick, marble, or stone) is 0" when using the included Island Trim. Clearances of less than 6" (152 mm) should be approved by the local codes and/or by the local authority having jurisdiction. Clearances from non-combustible materials are not part of the ANSI Z21.1 scope and are not certified by CSA.

The information contained in this document is BSH Home Appliances Corporation's proprietary and confidential information. The release or disclosure of this information without the prior written consent of BSH Home Appliances Corporation is strictly forbidden.

PRO HARMONY® SERIES INDUCTION RANGES

This price list supersedes all previous price lists. Prices listed herein do not include applicable state or local taxes.

Model Number	Description	UMRP	MSRP
--------------	-------------	------	------

All Pro Harmony® Series Induction Ranges include the Following Features:

- Frameless black glass cooktop covers the surface from edge-to-edge seamlessly fitting into any kitchen
 - Provides true design flexibility—it can be installed flush against combustible wall with zero rear clearance* and designed to fit perfectly flush alongside standard 24" depth cabinets
 - True Convection oven with a third element adds greater efficiency to cook up to five levels of sheet pans evenly
 - Super fast 2-hour self-clean mode is the fastest in the industry
 - Connect to your range for remote pre-heating and monitoring via the Home Connect® app, smartwatch and other smart home devices and services
- Main oven features:**
- Full Access telescopic racks with integrated easy-grip handle (1 in 30" Oven; 3 in 36" Oven)
 - Hidden Thermal Bake (2,000 W), Broil (4,000 W),
 - Third element rear 2,750 W convection

30" Induction Range

- The Liberty® cooktop comes with two large flexible cooking zones and FlexPlus™** heating elements that provide the ultimate in cooking performance and flexibility with HeatShift®, MoveMode®, and PowerBoost®

- Main oven features:**
- 4.4 cu. ft. overall volume*



PRI30LBHU



Left Full Zone 15" x 8½" @ 3,300 W/3,600 W (PowerBoost®)	LR: 7½" x 8½" @ 2,200 W/3,600 W (PowerBoost®)	RR: 7½" x 8½" @ 2,200 W/3,600 W (PowerBoost®)	Right Full Zone 15" x 8½" @ 3,300 W/3,600 W (PowerBoost®)
	LF: 7½" x 8½" @ 2,200 W/3,600 W (PowerBoost®)	RF: 7½" x 8½" @ 2,200 W/3,600 W (PowerBoost®)	
	Left FlexPlus Zone 3 ½" x 11 ¼"	Right FlexPlus Zone 3 ½" x 11 ¼"	

PRI30LBHU 30" Liberty Induction Cooktop Pro Harmony Range 8,399 9,249

36" Induction Range

- The Liberty® cooktop comes with three large flexible cooking zones that provide the ultimate in cooking performance and flexibility with HeatShift®, MoveMode®, and PowerBoost®

- Main oven features:**
- 4.9 cu. ft. overall volume*



PRI36LBHU



Left Full Zone 15" x 8½" @ 3,300 W/3,600 W (PowerBoost®)	LR: 7½" x 8½" @ 2,200 W/3,600 W (PowerBoost®)	Center Full Zone 11" x 9½" @ 3,300 W/3,600 W (PowerBoost®)	RR: 7½" x 8½" @ 2,200 W/3,600 W (PowerBoost®)	Right Full Zone 15" x 8½" @ 3,300 W/3,600 W (PowerBoost®)
	LF: 7½" x 8½" @ 2,200 W/3,600 W (PowerBoost®)		RF: 7½" x 8½" @ 2,200 W/3,600 W (PowerBoost®)	

PRI36LBHU 36" Liberty Induction Cooktop Pro Harmony Range 11,599 12,799

*According to AHAM Standards

NOTE: Models PCG305xx, PRD305xx, PRD606xx, PRG305xx, PRG304xx, PRD304xx, PRx488xx, PRIxxxxxx are suitable for 0" rear clearance to combustible surfaces. All other models: when using the included Island Trim a minimum 6" (152 mm) rear clearance is required to a combustible surface. When installing against a combustible surface, a Thermador Low Backguard is required for a 0" rear clearance to the combustible surface. A Thermador Low Backguard must be purchased separately. A rear clearance to a surface covered in a noncombustible material (metal, ceramic tile, brick, marble, or stone) is 0" when using the included Island Trim. Clearances of less than 6" (152 mm) should be approved by the local codes and/or by the local authority having jurisdiction. Clearances from non-combustible materials are not part of the ANSI Z21.1 scope and are not certified by CSA.

The information contained in this document is BSH Home Appliances Corporation's proprietary and confidential information. The release or disclosure of this information without the prior written consent of BSH Home Appliances Corporation is strictly forbidden.

PRO HARMONY® SERIES DUAL-FUEL RANGES

This price list supersedes all previous price lists. Prices listed herein do not include applicable state or local taxes.

Model Number	Description	UMRP	MSRP
--------------	-------------	------	------

All Pro Harmony® Series Dual Fuel Ranges Include the Following Features:

- Cabinet-Depth (24")
 - Four pedestal burner range: each front burner has output of 18,000 BTU (NG)
 - Continuous porcelain, easy-to-clean cooking surface
 - Patented Pedestal Star® Burner with QuickClean Base™
 - Metal knobs (also available in Metallic Blue, knob kit sold separately. See page 5-10)
 - All burners with electronic ignition/re-ignition
 - Precision simmering capabilities with two ExtraLow® simmer burners
 - For LP: Natural to LP Gas Field Conversion Kit must be ordered separately.
 - PAALTKITH High Altitude conversion kit is available for all Pro Harmony Ranges.
 - Island trim included
 - Two-year warranty
 - Star-K certified
- Griddle model:**
- 1,630 W electric element, thermostatically controlled, non-stick surface coating, cast-aluminum
- Main oven features:**
- Full Access® telescopic racks with integrated easy-grip handle (36" and 48" ovens: 3; 30" oven: 1)
 - Hidden Thermal Bake (2,000 W), Broil (4,000 W)
- Third element rear 2,750 W convection
 - Convection Broil and two rapid, self-clean cycles: 3 hr heavy-soil clean (36" & 48" Ranges only) and 1½ hr light-soil clean
- Secondary oven features:**
- 18" auxiliary oven on 48" range only
 - Hidden Thermal Bake, Broil, Warming, Proofing, and 2-hour self-clean
 - 2,600 W broil and 1,400 W bake elements,
 - 2.4 cu. ft. overall volume*
- Note**
- Professional-style ventilation is HIGHLY RECOMMENDED (see Thermador Professional hoods)

30" Dual-Fuel Range

- Four Pedestal Star® Burners (Two with ExtraLow®)
- 30" range features 4.4 cu. ft. overall volume*

LR: BTU 15,000 high**/XLO	RR: BTU 15,000 high**/3,000 low
LF: BTU 18,000 high**/XLO	RF: BTU 18,000 high**/3,000 low

PRD304WHU	30" Stainless Steel with Porcelain Surface and One Telescopic Oven Rack	6,799	7,499
------------------	---	-------	-------



PRD304WHU



- Five Pedestal Star® Burners (Two with ExtraLow®); overall output of 59,000 BTU and suitable for use with the Thermador OTR (see page 3-13)
- 30" range features 4.4 cu. ft. overall volume*

LR: BTU 8,000 high**/XLO	Center: BTU 10,000 high**	RR: BTU 8,000 high**
LF: BTU 18,000 high**/XLO		RF: BTU 15,000 high**

PRD305WHU	30" Stainless Steel with Porcelain Surface and One Telescopic Oven Rack	7,799	8,599
------------------	---	-------	-------



PRD305WHU



*According to AHAM Standards

** 8,000 BTU NG burners convert to 6,000 BTU LP; 10,000 BTU NG burners convert to 9,100 BTU LP; 15,000 BTU NG burners convert to 12,000 BTU LP; 18,000 BTU NG convert to 15,000 BTU LP; 22,000 BTU NG convert to 18,000 BTU LP

NOTE: Models PCG305xx, PRD305xx, PRD606xx, PRG305xx, PRG304xx, PRD304xx, PRx488xx, PRlxxxxx are suitable for 0" rear clearance to combustible surfaces. All other models: when using the included Island Trim a minimum 6" (152 mm) rear clearance is required to a combustible surface. When installing against a combustible surface, a Thermador Low Backguard is required for a 0" rear clearance to the combustible surface. A Thermador Low Backguard must be purchased separately. A rear clearance to a surface covered in a noncombustible material (metal, ceramic tile, brick, marble, or stone) is 0" when using the included Island Trim. Clearances of less than 6" (152 mm) should be approved by the local codes and/or by the local authority having jurisdiction. Clearances from non-combustible materials are not part of the ANSI Z21.1 scope and are not certified by CSA.

The information contained in this document is BSH Home Appliances Corporation's proprietary and confidential information. The release or disclosure of this information without the prior written consent of BSH Home Appliances Corporation is strictly forbidden.

PRO HARMONY® SERIES DUAL-FUEL RANGES

This price list supersedes all previous price lists. Prices listed herein do not include applicable state or local taxes.

Model Number	Description	UMRP	MSRP
--------------	-------------	------	------

36" Dual-Fuel Range

- Six Pedestal Star® Burners (Two with ExtraLow®)
- Oven features 4.9 cu. ft. overall volume*
- Thermador Connected Experience with Home Connect™

LR: BTU 15,000 high**/XLO	CR: BTU 15,000 high**/3,000 low	RR: BTU 15,000 high**/3,000 low
LF: BTU 18,000 high**/XLO	CF: BTU 18,000 high**/3,000 low	RF: BTU 18,000 high**/3,000 low

PRD366WHU	36" Stainless Steel with Porcelain Surface and All Telescopic Oven Racks	9,999	10,999
------------------	--	-------	--------



PRD366WHU



- Four Pedestal Star® Burners (Two with ExtraLow®)
- Oven features 4.9 cu. ft. overall volume*
- Thermador Connected Experience with Home Connect™
- Non-stick surface Electric Griddle, convertible to Grill with optional accessory PA12GRILLW or PA12GRILFW

LR: BTU 15,000 high**/XLO	Electric Griddle 1,630 W (6-pass)	RR: BTU 15,000 high**/3,000 low
LF: BTU 18,000 high**/XLO		RF: BTU 18,000 high**/3,000 low

PRD364WDHU	36" Stainless Steel with Porcelain Surface and All Telescopic Oven Racks	10,499	11,549
-------------------	--	--------	--------



PRD364WDHU



48" Dual-Fuel Range

- Six Pedestal Star® Burners (Two with ExtraLow®)
- Main oven features 4.4 cu. ft. overall volume*
- Thermador Connected Experience with Home Connect™
- Non-stick surface Electric Griddle, convertible to Grill with optional accessory PA12GRILLW or PA12GRILFW

LR: BTU 15,000 high**/XLO	CR: BTU 15,000 high**/3,000 low	Electric Griddle 1,630 W (6-pass)	RR: BTU 15,000 high**/3,000 low
LF: BTU 18,000 high**/XLO	CF: BTU 18,000 high**/3,000 low		RF: BTU 18,000 high**/3,000 low

PRD486WDHU	48" Stainless Steel with Porcelain Surface and All Telescopic Oven Racks	14,699	16,199
-------------------	--	--------	--------



PRD486WDHU



* According to AHAM Standards

** 15,000 BTU NG burners convert to 12,000 BTU LP; 18,000 BTU NG convert to 15,000 BTU LP; 22,000 BTU NG convert to 18,000 BTU LP

NOTE: Models PCG305xx, PRD305xx, PRD606xx, PRG305xx, PRG304xx, PRD304xx, PRx488xx, PRlxxxxx are suitable for 0" rear clearance to combustible surfaces. All other models: when using the included Island Trim a minimum 6" (152 mm) rear clearance is required to a combustible surface. When installing against a combustible surface, a Thermador Low Backguard is required for a 0" rear clearance to the combustible surface. A Thermador Low Backguard must be purchased separately. A rear clearance to a surface covered in a noncombustible material (metal, ceramic tile, brick, marble, or stone) is 0" when using the included Island Trim. Clearances of less than 6" (152 mm) should be approved by the local codes and/or by the local authority having jurisdiction. Clearances from non-combustible materials are not part of the ANSI Z21.1 scope and are not certified by CSA.

The information contained in this document is BSH Home Appliances Corporation's proprietary and confidential information. The release or disclosure of this information without the prior written consent of BSH Home Appliances Corporation is strictly forbidden.

PRO HARMONY® SERIES GAS RANGES

This price list supersedes all previous price lists. Prices listed herein do not include applicable state or local taxes.

Model Number	Description	UMRP	MSRP
--------------	-------------	------	------

All Pro Harmony® Series All Gas Ranges Include the Following Features:

- Cabinet-Depth (24")
- Four pedestal burner ; range: each front burner has output of 18,000 BTU (NG)
- All burners with electronic ignition/ re-ignition
- Continuous porcelain, easy-to-clean cooking surface
- Patented Pedestal Star® Burner with QuickClean Base™
- Metal knobs (also available in Metallic Blue, knob kit sold separately. See page 5-10)
- Precision simmering capabilities with two ExtraLow® simmer burners
- Griddle is interchangeable with grill accessory for convenient indoor grilling
- Gas ranges are field convertible from natural gas to liquid propane— Conversion Kit must be ordered separately
- Island trim included
- Two-year warranty
- Star-K certified
- Griddle model:**
 - 1,630 W electric element, thermostatically controlled, non-stick surface coating, cast-aluminum
- Ovens feature:**
 - 17,500 BTU high-intensity infrared broiler
 - Full Access® telescopic racks with integrated easy-grip handle (36" and 48" ovens: 3; 30" oven: 1)
- Gas convection oven
- 20,500 BTU bake burner
- Convection Bake, Thermal Bake (20,500 BTU)
- Secondary oven features:**
 - 18" auxiliary oven on 48" range only
 - Hidden Thermal Bake, Broil, Warming, Proofing, and 2-hour self-clean
 - 2,600 W broil and 1,400 W bake elements,
 - 2.4 cu. ft. overall volume*
- Note**
 - Professional-style ventilation is HIGHLY RECOMMENDED (see Thermador Professional hoods)

30" Gas Range

- Four Pedestal Star® Burners (Two with ExtraLow®) each
 - front burner has output of 18,000 BTU (NG)
 - 30" range features 4.6 cu. ft. overall volume*
- | | |
|------------------------------|------------------------------------|
| LR: BTU
15,000 high**/XLO | RR: BTU
15,000 high**/3,000 low |
| LF: BTU
18,000 high**/XLO | RF: BTU
18,000 high**/3,000 low |

PRG304WH 30" Stainless Steel with Porcelain Surface 5,299 5,849



PRG304WH



- Five Pedestal Star® Burners (Two with ExtraLow®); overall output of 59,000 BTU
 - and suitable for use with the Thermador OTR (see page 3-13).
 - 30" range features 4.6 cu. ft. overall volume*
- | | | |
|------------------------------|------------------------------|--------------------------|
| LR: BTU
8,000 high**/XLO | Center: BTU
10,000 high** | RR: BTU
8,000 high** |
| LF: BTU
18,000 high**/XLO | | RF: BTU
15,000 high** |

PRG305WH 30" Stainless Steel with Porcelain Surface 5,999 6,599



PRG305WH



* According to AHAM Standards

** 8,000 BTU NG burners convert to 6,000 BTU LP; 10,000 BTU NG burners convert to 9,100 BTU LP; 15,000 BTU NG burners convert to 12,000 BTU LP; 18,000 BTU NG convert to 15,000 BTU LP; 22,000 BTU NG convert to 18,000 BTU LP

NOTE: Models PCG305xx, PRD305xx, PRD606xx, PRG305xx, PRG304xx, PRD304xx, PRx488xx, PRlxxxxx are suitable for 0" rear clearance to combustible surfaces. All other models: when using the included Island Trim a minimum 6" (152 mm) rear clearance is required to a combustible surface. When installing against a combustible surface, a Thermador Low Backguard is required for a 0" rear clearance to the combustible surface. A Thermador Low Backguard must be purchased separately. A rear clearance to a surface covered in a noncombustible material (metal, ceramic tile, brick, marble, or stone) is 0" when using the included Island Trim. Clearances of less than 6" (152 mm) should be approved by the local codes and/or by the local authority having jurisdiction. Clearances from non-combustible materials are not part of the ANSI Z21.1 scope and are not certified by CSA.

The information contained in this document is BSH Home Appliances Corporation's proprietary and confidential information. The release or disclosure of this information without the prior written consent of BSH Home Appliances Corporation is strictly forbidden.

PRO HARMONY® SERIES GAS RANGES

This price list supersedes all previous price lists. Prices listed herein do not include applicable state or local taxes.

Model Number	Description	UMRP	MSRP
--------------	-------------	------	------

36" Gas Range

- Six Pedestal Star® Burners (Two with ExtraLow®)
- 36" range features 5.1 cu. ft. overall volume*
- Thermador Connected Experience with Home Connect™

LR: BTU 15,000 high**/XLO	CR: BTU 15,000 high**/3,000 low	RR: BTU 15,000 high**/3,000 low
LF: BTU 18,000 high**/XLO	CF: BTU 18,000 high**/3,000 low	RF: BTU 18,000 high**/3,000 low



PRG366WH 36" Stainless Steel with Porcelain Surface and All Telescopic Oven Racks 7,199 7,949

PRG366WH



- Four Pedestal Star® Burners (Two with ExtraLow®) each front burner has output of 18,000 BTU (NG)
- 36" range features 5.1 cu. ft. overall volume*
- Thermador Connected Experience with Home Connect™
- Non-stick surface Electric Griddle, convertible to Grill with optional accessory PA12GRILLW or PA12GRILFW

LR: BTU 15,000 high**/XLO	Electric Griddle 1,630 W (6-pass)	RR: BTU 15,000 high**/3,000 low
LF: BTU 18,000 high**/XLO		RF: BTU 18,000 high**/3,000 low



PRG364WDH 36" Stainless Steel with Porcelain Surface and All Telescopic Oven Racks 8,449 9,299

PRG364WDH



48" Gas Range

- Six Pedestal Star® Burners (Two with ExtraLow®) and
- Main oven features 4.6 cu. ft. overall volume*
- Thermador Connected Experience with Home Connect™
- Non-stick surface Electric Griddle, convertible to Grill with optional accessory PA12GRILLW or PA12GRILFW

LR: BTU 15,000 high**/XLO	CR: BTU 15,000 high**/3,000 low	Electric Griddle 1,630 W (6-pass)	RR: BTU 15,000 high**/3,000 low
LF: BTU 18,000 high**/XLO	CF: BTU 18,000 high**/3,000 low		RF: BTU 18,000 high**/3,000 low



PRG486WDH 48" Stainless Steel with Porcelain Surface and All Telescopic Oven Racks 11,799 12,999

PRG486WDH



* According to AHAM Standards







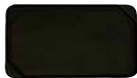
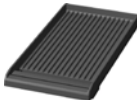
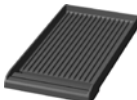

** 15,000 BTU NG burners convert to 12,000 BTU LP; 18,000 BTU NG convert to 15,000 BTU LP; 22,000 BTU NG convert to 18,000 BTU LP

NOTE: Models PCG305xx, PRD305xx, PRD606xx, PRG305xx, PRG304xx, PRD304xx, PRx488xx, PRlxxxxx are suitable for 0" rear clearance to combustible surfaces. All other models: when using the included Island Trim a minimum 6" (152 mm) rear clearance is required to a combustible surface. When installing against a combustible surface, a Thermador Low Backguard is required for a 0" rear clearance to the combustible surface. A Thermador Low Backguard must be purchased separately. A rear clearance to a surface covered in a noncombustible material (metal, ceramic tile, brick, marble, or stone) is 0" when using the included Island Trim. Clearances of less than 6" (152 mm) should be approved by the local codes and/or by the local authority having jurisdiction. Clearances from non-combustible materials are not part of the ANSI Z21.1 scope and are not certified by CSA.

The information contained in this document is BSH Home Appliances Corporation's proprietary and confidential information. The release or disclosure of this information without the prior written consent of BSH Home Appliances Corporation is strictly forbidden.

RANGETOPS & PRO HARMONY SERIES RANGES ACCESSORIES











This price list supersedes all previous price lists. Prices listed herein do not include applicable state or local taxes.

Model Number	Description	UMRP	MSRP	Accessories												
				Rangetops				Pro Harmony Ranges								
				Gas				Induction		Dual Fuel			All Gas			
				30	36	48		30	36	30	36	48	30	36	48	
PCG305W	PCG364WD	PCG366W	PCG486WD	PRI30LBHU	PRI36LBHU	PRD305WHU	PRD304WHU	PRD366WHU	PRD364WDHU	PRD486WDHU	PRG305WH	PRG304WH	PRG366WH	PRG364WDH	PRG486WDH	
	PAGRIDDLE Griddle sits on top of Grates over two Burners, high-release surface coating	199	219													
	PA12GRILFW 12" Grill Plate Accessory w/ Tray (for Griddle Modules) (Fusion coating) Fusion coated accessories offered as an alternative to the "high-release" accessories.	319	359													
	PA12GRILLW 12" Grill Plate Accessory w/ Tray (for Griddle Modules) Non-stick (non-fusion) surface coating ("high-release") is easy to clean and durable over time.	319	359													
	PA12CHPBLK 12" Maple Chopping Board	199	219													
	PA12LCVRW 12" Professional Griddle Cover Grill model s not listed in price book.	209	229													
	PWOKRINGHC Wok Ring Accessory	199	219													
	PALPKITHW LP Conversion Kit Pro Harmony Dual Fuel Ranges & Rangetops (4 & 6 Burner)	139	159													
	PALPKITHW5 LP Conversion Kit Pro Harmony Dual Fuel Ranges & Rangetops (5 Burner)	139	159													
	PALPKITGA LP Conversion Kit Pro Harmony Gas Ranges, 30" & 36" (4 & 6 Burner)	199	219													
	PALPKITHA5 LP Conversion Kit Pro Harmony Gas Ranges (5 Burner)	139	159													

The information contained in this document is BSH Home Appliances Corporation's proprietary and confidential information. The release or disclosure of this information without the prior written consent of BSH Home Appliances Corporation is strictly forbidden.

RANGETOPS & PRO HARMONY SERIES RANGES ACCESSORIES

This price list supersedes all previous price lists. Prices listed herein do not include applicable state or local taxes.







	Model Number	Description	UMRP	MSRP	Accessories													
					Rangetops						Pro Harmony Ranges							
					Gas			Induction			Dual Fuel			All Gas				
					30	36	48	30	36	30	36	48	30	36	48			
	PALPKITGA6	LP Conversion Kit Pro Harmony Gas Ranges 48" (4 & 6 Burner)	199	219														•
	PAALTKITH	High Altitude Kit Pro Harmony Ranges & Rangetops	89	99	•	•	•	•			•	•	•	•	•	•	•	•
	PAKNOBLUWR	Metallic Blue Knob Kit Pro Rangetop	239	269	•	•	•	•										
	PARKB30HY	Blue Knob Kit 30" Dual Fuel Harmony	249	279						•	•							
	PARKB3XHY	Blue Knob Kit 30"/36" Gas Harmony	249	279									•	•	•			
	PARKB3XIHB	Blue Knob Kit 30"/36" Induction Harmony	149	169					•	•								
	PARKB36DHY	Blue Knob Kit 36" Gas/Dual Fuel Harmony	249	279								•					•	
	PARKB36HY	Blue Knob Kit 36" Dual Fuel GR Harmony	249	279								•						
	PARKB48CHY	Blue Knob Kit 48" Dual Fuel Harmony	299	329									•					
	PARKB48DHY	Blue Knob Kit 48" Gas Harmony	299	329														•

NOTE: Models PCG305xx, PRD305xx, PRD606xx, PRG305xx, PRG304xx, PRD304xx, PRx488xx, PRlxxxxxx are suitable for 0" rear clearance to combustible surfaces. All other models: when using the included Island Trim a minimum 6" (152 mm) rear clearance is required to a combustible surface. When installing against a combustible surface, a Thermador Low Backguard is required for a 0" rear clearance to the combustible surface. A Thermador Low Backguard must be purchased separately. A rear clearance to a surface covered in a noncombustible material (metal, ceramic tile, brick, marble, or stone) is 0" when using the included Island Trim. Clearances of less than 6" (152 mm) should be approved by the local codes and/or by the local authority having jurisdiction. Clearances from non-combustible materials are not part of the ANSI Z21.1 scope and are not certified by CSA.

The information contained in this document is BSH Home Appliances Corporation's proprietary and confidential information. The release or disclosure of this information without the prior written consent of BSH Home Appliances Corporation is strictly forbidden.

RANGETOPS & PRO HARMONY SERIES RANGES ACCESSORIES

This price list supersedes all previous price lists. Prices listed herein do not include applicable state or local taxes.

	Model Number	Description	UMRP	MSRP	Accessories																	
					Rangetops				Pro Harmony Ranges													
					Gas			Induction		Dual Fuel			All Gas									
					30	36	48	30	36	30	36	48	30	36	48							
	PA30WLBH	7" Low Back 30" Gas/Dual Fuel Pro Harmony Range	419	469																		
	PA36WLBH	7" Low Back 36" Gas/Dual Fuel Pro Harmony Range	479	529																		
	PA48WLBH	7" Low Back 48" Gas/Dual Fuel Pro Harmony Range	509	599																		
	PA30WLBC	10" Low Backguard for 30" Rangetop	209	229																		
	PA36WLBC	10" Low Backguard for 36" Rangetop	269	299																		
	PA48WLBC	10" Low Backguard for 48" Rangetop	319	359																		

The information contained in this document is BSH Home Appliances Corporation's proprietary and confidential information. The release or disclosure of this information without the prior written consent of BSH Home Appliances Corporation is strictly forbidden.

PRO GRAND® SERIES DUAL-FUEL WITH STEAM RANGES

This price list supersedes all previous price lists. Prices listed herein do not include applicable state or local taxes.

Model Number	Description	UMRP	MSRP
--------------	-------------	------	------

All Pro Grand® Series Dual Fuel Steam Ranges Include the Following Features:

- | | | |
|---|---|---|
| <ul style="list-style-type: none"> • Commercial-depth (27") • Featuring Pedestal Star® Burners with QuickClean Base™ (Four with ExtraLow® Simmer) • Steam and convection oven • Warming drawer • Continuous porcelain, easy-to-clean cooking surface • Patented Pedestal Star® Burner with QuickClean Base™ • Metal knobs (also available in Metallic Blue, knob kit sold separately. See page 5-19) • Powerful burners with electronic ignition/re-ignition plus one XHI power burner (left-front) 22,000 BTU (NG) (XHI 18,000 BTU LP) • Precision simmering capabilities with Four ExtraLow® Simmer burners (two far-left pair and two far-right pair) • Induction Models (48" dual-fuel models): featuring the Thermador 3,600 W Liberty® surface with two zones—Features 9 power levels, XHI PowerBoost, Bridge, HeatShift®, Timer and a safety shutoff • Electric Griddle (convertible to grill with grill accessory) • 24" Two Zone Electric Griddle (60" models) • Griddle model: 1,630 W electric element, thermostatically controlled, non-stick surface coating, cast-aluminum • LP conversion kit ordered separately for | <ul style="list-style-type: none"> converting burners for LP gas • Island trim is included • Panel lighting illuminates knob controls • Two-year warranty • Star-K certified • CSA certified <p>Oven features:</p> <ul style="list-style-type: none"> • Thermador Connected Experience with Home Connect™ enables oven control and monitoring as well as access to guided Thermador recipes, services and exclusive content; plus compatibility with other smart devices, like Amazon 'Alexa' • SoftClose® hinges for ultra-smooth closing • Large oven includes three Full Access® telescopic racks with integrated easy-grip handles • Largest convection oven features 4.9 cu. ft. (48" models) • 5.7 cu. ft. (60" models) overall volume* • Fast Preheat • 4,000 W 8-pass broil and 2,000 W bake elements • Third Element Convection (2,750 W) for multi-rack cooking • Multi-Point temperature probe for Bake and Roast modes captures temperatures at multiple points for more accurate results • Two rapid, self-clean cycles: 3 hr heavy-soil clean and 1 ½ hr light-soil clean • Electronic oven display interfaces to Fast Preheat, Sabbath mode, cook timer, | <ul style="list-style-type: none"> temperature probe, convection conversion and preheat status with audible alert <p>Steam Oven features:</p> <ul style="list-style-type: none"> • 27 Easy Cook® programs • 9 advanced conventional cooking modes: Steam, steam convection, reheat, defrost, slow cook, keep warm, proof, true convection, and steam programs • 2,750 W convection element • 1.6 cu. ft. steam cavity easily accommodates a 14 lb. turkey • Non-plumbed • Steam Clean function <p>Warming drawer features:</p> <ul style="list-style-type: none"> • Open sides for convenient accessibility • Holds up to ten 11" dinner plates • Exclusive smooth surface warming drawer • Three heat settings <p>Note</p> <ul style="list-style-type: none"> • It is strongly recommended that this appliance be installed in conjunction with a Thermador vent hood. (see Thermador Professional Hoods, page 6-5) • For Liquid Propane models: Natural to LP Gas Field Conversion Kit must be ordered separately. For altitudes above 5,400 ft., see High Altitude Kits. |
|---|---|---|

* According to AHAM Standards

NOTE: Models PCG305xx, PRD305xx, PRD606xx, PRG305xx, PRG304xx, PRD304xx, PRx488xx, PRxxxxxx are suitable for 0" rear clearance to combustible surfaces. All other models: when using the included Island Trim a minimum 6" (152 mm) rear clearance is required to a combustible surface. When installing against a combustible surface, a Thermador Low Backguard is required for a 0" rear clearance to the combustible surface. A Thermador Low Backguard must be purchased separately. A rear clearance to a surface covered in a noncombustible material (metal, ceramic tile, brick, marble, or stone) is 0" when using the included Island Trim. Clearances of less than 6" (152 mm) should be approved by the local codes and/or by the local authority having jurisdiction. Clearances from non-combustible materials are not part of the ANSI Z21.1 scope and are not certified by CSA.

The information contained in this document is BSH Home Appliances Corporation's proprietary and confidential information. The release or disclosure of this information without the prior written consent of BSH Home Appliances Corporation is strictly forbidden.

PRO GRAND® SERIES DUAL-FUEL WITH STEAM RANGES

This price list supersedes all previous price lists. Prices listed herein do not include applicable state or local taxes.

Model Number	Description	UMRP	MSRP
--------------	-------------	------	------

48" Dual-Fuel with Steam Range

The Ultimate Culinary Center™

- Six Pedestal Star® Burners (Four with ExtraLow®)
- Griddle, convertible to Grill with optional accessory PA12GRILLW or PA12GRILFW

LR: BTU 15,000 high*/XLO	CR: BTU 15,000 high*/3,000 low	Electric Griddle 1,630 W (6-pass)	RR: BTU 15,000 high*/XLO
LF: BTU 22,000 XHI*/XLO	CF: BTU 18,000 high*/3,000 low		RF: BTU 18,000 high*/XLO

PRD48WDSGU	48" Stainless Steel with Porcelain Surface and All Telescopic Oven Racks (main oven)	18,299	20,149
-------------------	--	--------	--------



The Ultimate Culinary Center™

- Six Pedestal Star® Burners (Four with ExtraLow®)
- Liberty® Induction.

LR: BTU 15,000 high*/XLO	CR: BTU 15,000 high**/3,000 low	RR: BTU 15,000 high*/XLO	Induction 3,600 W 230 V 3,300 W 208 V
LF: BTU 22,000 XHI*/XLO	CF: BTU 18,000 high*/3,000 low	RF: BTU 18,000 high*/XLO	

PRD48WISGU	48" Stainless Steel with Porcelain Surface and All Telescopic Oven Racks (main oven)	19,149	21,099
-------------------	--	--------	--------



60" Dual-Fuel with Steam Range

The Ultimate Entertainer's Center™

- Six Pedestal Star® Burners (Four with ExtraLow®)
- 24" Dual Zone Griddle
- 5.7 cu. ft. main oven cavity accommodates commercial size full sheet pan •
- 24" stainless steel cover accessory PA24CVRR for 24" Griddle sold separately

LR: BTU 12,500 high**/XLO	CR: BTU 12,500 high**/3,000 low	24" Electric Griddle 1,630 W (Left & Right) (3,260 W total)	RR: BTU 15,000 high**/XLO
LF: BTU 22,000 XHI**/XLO	CF: BTU 18,000 high**/3,000 low		RF: BTU 18,000 high**/XLO

PRD606WESG	60" Stainless Steel with Porcelain Surface and All Telescopic Oven Racks (main oven)	23,249	25,599
-------------------	--	--------	--------



* 15,000 BTU NG burners convert to 12,000 BTU LP; 18,000 BTU NG convert to 15,000 BTU LP; 22,000 BTU NG convert to 18,000 BTU LP
 ** 12,500 BTU NG burners convert to 11,000 BTU LP; 15,000 BTU NG burners convert to 12,000 BTU LP; 18,000 BTU NG convert to 15,000 BTU LP; 22,000 BTU NG convert to 18,000 BTU LP

NOTE: Models PCG305xx, PRD305xx, PRD606xx, PRG305xx, PRG304xx, PRD304xx, PRx488xx, PRlxxxxxx are suitable for 0" rear clearance to combustible surfaces. All other models: when using the included Island Trim a minimum 6" (152 mm) rear clearance is required to a combustible surface. When installing against a combustible surface, a Thermador Low Backguard is required for a 0" rear clearance to the combustible surface. A Thermador Low Backguard must be purchased separately. A rear clearance to a surface covered in a noncombustible material (metal, ceramic tile, brick, marble, or stone) is 0" when using the included Island Trim. Clearances of less than 6" (152 mm) should be approved by the local codes and/or by the local authority having jurisdiction. Clearances from non-combustible materials are not part of the ANSI Z21.1 scope and are not certified by CSA.

The information contained in this document is BSH Home Appliances Corporation's proprietary and confidential information. The release or disclosure of this information without the prior written consent of BSH Home Appliances Corporation is strictly forbidden.

This price list supersedes all previous price lists. Prices listed herein do not include applicable state or local taxes.

Model Number	Description	UMRP	MSRP
--------------	-------------	------	------

All Pro Grand® Series Dual Fuel Ranges Include the Following Features:

- Commercial-Depth (27")
- Patented Pedestal Star® Burner with QuickClean Base™ (Four with ExtraLow® Simmer)
- Continuous porcelain, easy-to-clean cooking surface
- Metal knobs (also available in Metallic Blue, knob kit sold separately. See page 5-19.
- Powerful burners with electronic ignition/re-ignition plus one XHI power burner (left-front) 22,000 BTU (NG) (XHI 18,000 BTU LP)
- Precision simmering capabilities with four ExtraLow® Simmer burners (two far-left pair and two far-right pair)
- LP kit ordered separately for converting burners for LP gas
- Island trim is included
- Panel lighting illuminates knob controls
- Two-year warranty
- Star-K certified

All Ovens

- SoftClose® hydraulic hinges for ultra-smooth closing
- Three Full Access® telescopic racks with integrated easy-grip handles
- Fast Preheat

Main Oven

- Thermador Connected Experience with Home Connect™ enables oven control and monitoring as well as access to guided Thermador recipes, services and exclusive content; plus compatibility with other smart devices, like Amazon 'Alexa'
- Largest convection oven features a 5.7 cu. ft. overall volume* accommodates commercial size full sheet pan.
- 4,000 W 8-pass broil and 2,000 W bake elements
- Third Element Convection (2,750 W) for multi-rack cooking
- Multi-Point temperature probe for Bake and Roast modes captures temperatures at multiple points for more accurate results
- 9 modes including two rapid, self-clean cycles: 3 hr heavy-soil clean and 1 ½ hr light-soil clean
- Electronic oven display interfaces to Fast Preheat, Sabbath mode, cook timer, temperature probe, convection conversion, and preheat status with audible alert
- Hidden bake element

Note

- It is strongly recommended that this appliance be installed in conjunction with a Thermador vent hood. (see Thermador Professional Hoods, page 6-5)
- For Liquid Propane models: Natural to LP Gas Field Conversion Kit must be ordered separately. For altitudes above 5,400 ft., see High Altitude Kits.

Induction Models

- Thermador 3,600 W Liberty® Induction with two zones
- Features 9 power levels, XHI PowerBoost, Bridge, HeatShift®, Timer and a safety shutoff

Griddle:

- 1,630 W electric element, thermostatically controlled, non-stick surface coating, cast-aluminum
- Fusion non-stick surface

48" Range Full-featured Secondary Oven

- 9 modes including 2-hour self clean, Third Element Convection (1,960 W) and temperature probe for Roast
- 2,600 W 6-pass broil elements
- Oven features a 2.5 cu. ft. overall volume*
- Electronic oven display interfaces to Sabbath mode, cook timer, temperature probe and preheat status with audible alert

60" Range Full-featured Secondary Oven

- 9 modes including 2-hour self clean
- Third Element Convection (2,750 W)
- Temperature probe for Roast
- 4,000 W 6-pass broil elements
- Oven features a 4.9 cu. ft. overall volume*
- Electronic oven display interfaces to Sabbath mode, cook timer, temperature probe and preheat status with audible alert

* According to AHAM Standards

NOTE: Models PCG305xx, PRD305xx, PRD606xx, PRG305xx, PRG304xx, PRD304xx, PRx488xx, PRlxxxxx are suitable for 0" rear clearance to combustible surfaces. All other models: when using the included Island Trim a minimum 6" (152 mm) rear clearance is required to a combustible surface. When installing against a combustible surface, a Thermador Low Backguard is required for a 0" rear clearance to the combustible surface. A Thermador Low Backguard must be purchased separately. A rear clearance to a surface covered in a noncombustible material (metal, ceramic tile, brick, marble, or stone) is 0" when using the included Island Trim. Clearances of less than 6" (152 mm) should be approved by the local codes and/or by the local authority having jurisdiction. Clearances from non-combustible materials are not part of the ANSI Z21.1 scope and are not certified by CSA.

The information contained in this document is BSH Home Appliances Corporation's proprietary and confidential information. The release or disclosure of this information without the prior written consent of BSH Home Appliances Corporation is strictly forbidden.

PRO GRAND® SERIES DUAL-FUEL RANGES

This price list supersedes all previous price lists. Prices listed herein do not include applicable state or local taxes.

Model Number	Description	UMRP	MSRP
--------------	-------------	------	------

36" Dual-Fuel Ranges

- Six Pedestal Star® Burners (Four with ExtraLow®)

LR: BTU 15,000 high*/XLO	CR: BTU 15,000 high*/3,000 low	RR: BTU 15,000 high*/XLO
LF: BTU 22,000 XHI*/XLO	CF: BTU 18,000 high*/3,000 low	RF: BTU 18,000 high*/XLO

PRD366WGU	36" Stainless Steel with Porcelain Surface and All Telescopic Oven Racks	11,199	12,349
------------------	--	--------	--------



PRD366WGU



- Four Pedestal Star® Burners (Four with ExtraLow®) and

- Non-stick surface Electric Griddle, convertible to Grill with optional accessory PA12GRILLW or PA12GRILFW

LR: BTU 15,000 high*/XLO	Electric Griddle 1,630 W (6-pass)	RR: BTU 15,000 high*/XLO
LF: BTU 22,000 XHI*/XLO		RF: BTU 18,000 high*/XLO

PRD364WDGU	36" Stainless Steel with Porcelain Surface and All Telescopic Oven Racks	11,999	13,199
-------------------	--	--------	--------



PRD364WDGU



- Four Pedestal Star® Burners (Four with ExtraLow®) with Liberty® Induction

LR: BTU 15,000 high*/XLO	RR: BTU 15,000 high*/XLO	Induction 3,600 W 230 V 3,300 W 208 V
LF: BTU 22,000 XHI*/XLO	RF: BTU 18,000 high*/XLO	

PRD364WIGU	36" Stainless Steel with Porcelain Surface and All Telescopic Oven Racks	12,599	13,899
-------------------	--	--------	--------



PRD364WIGU



* 15,000 BTU NG burners convert to 12,000 BTU LP; 18,000 BTU NG convert to 15,000 BTU LP; 22,000 BTU NG convert to 18,000 BTU LP

NOTE: Models PCG305xx, PRD305xx, PRD606xx, PRG305xx, PRG304xx, PRD304xx, PRx488xx, PRlxxxxxx are suitable for 0" rear clearance to combustible surfaces. All other models: when using the included Island Trim a minimum 6" (152 mm) rear clearance is required to a combustible surface. When installing against a combustible surface, a Thermador Low Backguard is required for a 0" rear clearance to the combustible surface. A Thermador Low Backguard must be purchased separately. A rear clearance to a surface covered in a noncombustible material (metal, ceramic tile, brick, marble, or stone) is 0" when using the included Island Trim. Clearances of less than 6" (152 mm) should be approved by the local codes and/or by the local authority having jurisdiction. Clearances from non-combustible materials are not part of the ANSI Z21.1 scope and are not certified by CSA.

The information contained in this document is BSH Home Appliances Corporation's proprietary and confidential information. The release or disclosure of this information without the prior written consent of BSH Home Appliances Corporation is strictly forbidden.

PRO GRAND® SERIES DUAL-FUEL RANGES

This price list supersedes all previous price lists. Prices listed herein do not include applicable state or local taxes.

Model Number	Description	UMRP	MSRP
--------------	-------------	------	------

48" Dual-Fuel Ranges

- Six Pedestal Star® Burner Cooktop (Four with ExtraLow®) and fusion non-stick surface Electric Griddle
- Non-stick surface Electric Griddle, convertible to Grill with optional accessory PA12GRILLW or PA12GRILFW

LR: BTU 15,000 high*/XLO	CR: BTU 15,000 high*/3,000 low	Electric Griddle 1,630 W (6-pass)	RR: BTU 15,000 high*/XLO
LF: BTU 22,000 XHI*/XLO	CF: BTU 18,000 high*/3,000 low		RF: BTU 18,000 high*/XLO

PRD486WDGU	48" Stainless Steel with Porcelain Surface and All Telescopic Oven Racks	15,649	17,249
-------------------	--	--------	--------



PRD486WDGU



- Six Pedestal Star® Burner Cooktop (Four with ExtraLow®) with Liberty® Induction

LR: BTU 15,000 high*/XLO	CR: BTU 15,000 high*/3,000 low	RR: BTU 15,000 high*/XLO	Induction 3,600 W 230 V 3,300 W 208 V
LF: BTU 22,000 XHI*/XLO	CF: BTU 18,000 high*/3,000 low	RF: BTU 18,000 high*/XLO	

PRD486WIGU	48" Stainless Steel with Porcelain Surface and All Telescopic Oven Racks	15,999	17,599
-------------------	--	--------	--------



PRD486WIGU



60" Dual-Fuel Ranges

The Ultimate Entertainer's Center™

- Six Pedestal Star® Burners (Four with ExtraLow®) with 24" Dual Zone Griddle
- Non-stick surface Electric Griddle, convertible to Grill with optional accessory PA12GRILLW or PA12GRILFW

LR: BTU 12,500 high**/XLO	CR: BTU 12,500 high**/3,000 low	24" Electric Griddle 1,630 W (Left & Right) (3,260 W total)	RR: BTU 15,000 high**/XLO
LF: BTU 22,000 XHI**/XLO	CF: BTU 18,000 high**/3,000 low		RF: BTU 18,000 high**/XLO

PRD606WEG	60" Stainless Steel with Porcelain Surface and All Telescopic Oven Racks	20,199	22,249
------------------	--	--------	--------



PRD606WEG



* 12,500 BTU NG burners convert to 11,000 BTU LP; 15,000 BTU NG burners convert to 12,000 BTU LP; 18,000 BTU NG convert to 15,000 BTU LP; 22,000 BTU NG convert to 18,000 BTU LP

** 15,000 BTU NG burners convert to 12,000 BTU LP; 18,000 BTU NG convert to 15,000 BTU LP; 22,000 BTU NG convert to 18,000 BTU LP

NOTE: Models PCG305xx, PRD305xx, PRD606xx, PRG305xx, PRG304xx, PRD304xx, PRx488xx, PRlxxxxx are suitable for 0" rear clearance to combustible surfaces. All other models: when using the included Island Trim a minimum 6" (152 mm) rear clearance is required to a combustible surface. When installing against a combustible surface, a Thermador Low Backguard is required for a 0" rear clearance to the combustible surface. A Thermador Low Backguard must be purchased separately. A rear clearance to a surface covered in a noncombustible material (metal, ceramic tile, brick, marble, or stone) is 0" when using the included Island Trim. Clearances of less than 6" (152 mm) should be approved by the local codes and/or by the local authority having jurisdiction. Clearances from non-combustible materials are not part of the ANSI Z21.1 scope and are not certified by CSA.

The information contained in this document is BSH Home Appliances Corporation's proprietary and confidential information. The release or disclosure of this information without the prior written consent of BSH Home Appliances Corporation is strictly forbidden.

This price list supersedes all previous price lists. Prices listed herein do not include applicable state or local taxes.

Model Number	Description	UMRP	MSRP
--------------	-------------	------	------

All Pro Grand® Series All Gas Ranges Include the Following Features:

- Commercial-depth (27")
 - Featuring Patented Pedestal Star® Burner with QuickClean Base™ (Four with ExtraLow® Simmer),
 - Continuous porcelain, easy-to-clean cooking surface
 - Patented Pedestal Star® Burner with QuickClean Base™
 - Metal knobs (also available in Metallic Blue, knob kit sold separately. See page 5-19.
 - Powerful burners with electronic ignition/re-ignition plus one XHI power burner (left-front) 22,000 BTU (NG) (XHI 18,000 BTU LP)
 - Precision simmering capabilities with four ExtraLow® Simmer burners (two far-left pair and two far-right pair)
 - Gas ranges are field convertible from natural gas to liquid propane—kits sold separately
 - Island trim is included
 - Panel lighting illuminates knob controls
 - Two-year warranty
 - Star-K certified
- Griddle model:**
- 1,630 W electric element, thermostatically controlled, non-stick surface coating, cast-aluminum
 - Electric Griddle (convertible to grill with grill accessory),
- Oven features:**
- SoftClose® hydraulic hinges for ultra-smooth closing
 - Each oven includes three Full Access® telescopic racks with integrated easy-grip handles
- Large oven:**
- Thermador Connected Experience with Home Connect™ enables oven control and monitoring as well as access to guided Thermador recipes, services and exclusive content; plus compatibility with other smart devices, like Amazon 'Alexa'
 - 5.7 cu. ft. overall volume* accommodates commercial full-size sheet pan
 - 17,500 BTU high-intensity infrared broil burner (NG/LP)
 - Multi-Point temperature probe for Bake and Roast modes captures temperatures at multiple points for more accurate results
 - 6 conventional cooking modes
- Two rapid, self-clean cycles: 3 hr heavy-soil clean and 1 ½ hr light-soil clean
 - Electronic oven display interfaces to Sabbath mode, cook timer, temperature probe and preheat status with audible alert
- Full-featured Secondary Oven features:**
- 2.5 cu. ft. overall volume*
 - Six modes including convection, 2-hour self clean, and temperature probe for Roast
 - 15,000 BTU Bake and 7,000 BTU infrared broil burners (NG/LP)
 - Electronic oven display interfaces to Sabbath mode, cook timer, temperature probe and preheat status with audible alert
- Note**
- It is strongly recommended that this appliance be installed in conjunction with a Thermador vent hood. (see Thermador Professional Hoods, page 6-5)
 - For Liquid Propane models: Natural to LP Gas Field Conversion Kit must be ordered separately. For altitudes above 5,400 ft., see High Altitude Kits.

36" Gas Range

- Six Pedestal Star® Burners (Four with ExtraLow®)

LR: BTU 15,000 high**/XLO	CR: BTU 15,000 high**/3,000 low	RR: BTU 15,000 high**/XLO
LF: BTU 22,000 XHI**/XLO	CF: BTU 18,000 high**/3,000 low	RF: BTU 18,000 high**/XLO

PRG366WG 36" Stainless Steel with Porcelain Surface and All Telescopic Oven Racks 8,699 9,599



PRG366WG



*According to AHAM Standards

**15,000 BTU NG burners convert to 12,000 BTU LP; 18,000 BTU NG convert to 15,000 BTU LP; 22,000 BTU NG convert to 18,000 BTU LP

NOTE: Models PCG305xx, PRD305xx, PRD606xx, PRG305xx, PRG304xx, PRD304xx, PRx488xx, PRIxxxxxx are suitable for 0" rear clearance to combustible surfaces. All other models: when using the included Island Trim a minimum 6" (152 mm) rear clearance is required to a combustible surface. When installing against a combustible surface, a Thermador Low Backguard is required for a 0" rear clearance to the combustible surface. A Thermador Low Backguard must be purchased separately. A rear clearance to a surface covered in a noncombustible material (metal, ceramic tile, brick, marble, or stone) is 0" when using the included Island Trim. Clearances of less than 6" (152 mm) should be approved by the local codes and/or by the local authority having jurisdiction. Clearances from non-combustible materials are not part of the ANSI Z21.1 scope and are not certified by CSA.

The information contained in this document is BSH Home Appliances Corporation's proprietary and confidential information. The release or disclosure of this information without the prior written consent of BSH Home Appliances Corporation is strictly forbidden.

PRO GRAND® SERIES GAS RANGES/PRO GRAND® SERIES ACCESSORIES

This price list supersedes all previous price lists. Prices listed herein do not include applicable state or local taxes.

Model Number	Description	UMRP	MSRP
--------------	-------------	------	------

48" Gas Range

- Six Pedestal Star® Burners (Four with ExtraLow®)
- Non-stick surface Electric Griddle, convertible to Grill with optional accessory PA12GRILLW or PA12GRILFW



LR: BTU 15,000 high*/XLO	CR: BTU 15,000 high*/3,000 low	Electric Griddle 1,630 W (6-pass)	RR: BTU 15,000 high*/XLO
LF: BTU 22,000 XHI*/XLO	CF: BTU 18,000 high*/3,000 low		RF: BTU 18,000 high*/XLO

PRG486WDG 48" Stainless Steel with Porcelain Surface and All Telescopic Oven Racks 12,399 13,649 PRG486WDG



Accessories

					Dual-Fuel with Steam		Dual Fuel					All Gas	
					48"	60"	36"			48"	60"	36"	48"
					PRD48WISGU	PRD48WDSGU	PRD606WESG	PRD364WIGU	PRD366WVGU	PRD364WDGU	PRD486WIGU	PRD486WDGU	PRD606WEG
	PAGRIDDLE	Griddle sits on top of Grates over two Burners, high-release surface coating	199	219	•	•	•	•	•	•	•	•	•
	PA12GRILFW	12" Grill Plate Accessory w/ Tray (for Griddle Models) (Fusion coating) Fusion coated accessories offered as an alternative to the "high-release" accessories.	319	359		•	•				•	•	•
	PA12GRILLW	12" Grill Plate Accessory w/ Tray (for Griddle Models) Non-stick (non-fusion) surface coating ("high-release") is easy to clean and durable over time.	319	359		•	•				•	•	•
	PA12CHPBLK	12" Maple Chopping Board	199	219	•	•	•	•	•	•	•	•	•









* 15,000 BTU NG burners convert to 12,000 BTU LP; 18,000 BTU NG convert to 15,000 BTU LP; 22,000 BTU NG convert to 18,000 BTU LP

NOTE: Models PCG305xx, PRD305xx, PRD606xx, PRG305xx, PRG304xx, PRD304xx, PRx488xx, PRlxxxxxx are suitable for 0" rear clearance to combustible surfaces. All other models: when using the included Island Trim a minimum 6" (152 mm) rear clearance is required to a combustible surface. When installing against a combustible surface, a Thermador Low Backguard is required for a 0" rear clearance to the combustible surface. A Thermador Low Backguard must be purchased separately. A rear clearance to a surface covered in a noncombustible material (metal, ceramic tile, brick, marble, or stone) is 0" when using the included Island Trim. Clearances of less than 6" (152 mm) should be approved by the local codes and/or by the local authority having jurisdiction. Clearances from non-combustible materials are not part of the ANSI Z21.1 scope and are not certified by CSA.

The information contained in this document is BSH Home Appliances Corporation's proprietary and confidential information. The release or disclosure of this information without the prior written consent of BSH Home Appliances Corporation is strictly forbidden.

PRO GRAND® SERIES ACCESSORIES

This price list supersedes all previous price lists. Prices listed herein do not include applicable state or local taxes.











	Model Number	Description	UMRP	MSRP	Dual-Fuel with Steam			Dual Fuel			All Gas				
					48"	60"	36"			48"	60"	36"	48"		
					PRD48WISGU	PRD48WDSGU	PRD606WESG	PRD364WIGU	PRD366WIGU	PRD364WDGU	PRD486WIGU	PRD486WDGU	PRD606WEG	PRG366WG	PRG486WDG
	PA12LCVRW	12" Professional Griddle Cover	209	229		•				•		•			•
	PA24CVRR	24" Cover for Griddle	299	329			•					•			
	PWOKRINGHC	Wok Ring Accessory	199	219	•	•	•	•	•	•	•	•	•	•	•
	PALPKITDGW	LP Conversion Kit Pro Grand Dual Fuel Ranges	199	219	•	•	•	•	•	•	•	•			
	PALPKITGGW	LP Conversion Kit Pro Grand Gas Ranges	199	219									•	•	
	PAALTKITGW	High Altitude Kit, NG Pro Grand Ranges, 5.4K ft. to 10.2K ft.	89	99	•	•	•	•	•	•	•	•	•	•	•
	PARKB36IGY	Blue Knob Kit 36" Grill/Ind Grand	249	279				•							
	PARKB36GY	Blue Knob Kit 36" Gas Grand	249	279									•		
	PARKB36CGY	Blue Knob Kit 36" Combi Grand	279	309					•	•					

NOTE: Models PCG305xx, PRD305xx, PRD606xx, PRG305xx, PRG304xx, PRD304xx, PRx488xx, PRlxxxxx are suitable for 0" rear clearance to combustible surfaces. All other models: when using the included Island Trim a minimum 6" (152 mm) rear clearance is required to a combustible surface. When installing against a combustible surface, a Thermador Low Backguard is required for a 0" rear clearance to the combustible surface. A Thermador Low Backguard must be purchased separately. A rear clearance to a surface covered in a noncombustible material (metal, ceramic tile, brick, marble, or stone) is 0" when using the included Island Trim. Clearances of less than 6" (152 mm) should be approved by the local codes and/or by the local authority having jurisdiction. Clearances from non-combustible materials are not part of the ANSI Z21.1 scope and are not certified by CSA.

The information contained in this document is BSH Home Appliances Corporation's proprietary and confidential information. The release or disclosure of this information without the prior written consent of BSH Home Appliances Corporation is strictly forbidden.

PRO GRAND® SERIES ACCESSORIES

This price list supersedes all previous price lists. Prices listed herein do not include applicable state or local taxes.



























Model Number	Description	UMRP	MSRP	Dual-Fuel with Steam			Dual Fuel			All Gas				
				48"		60"	36"			48"		60"	36"	48"
				PRD48WISGU	PRD48WDSGU	PRD60WESG	PRD364WIGU	PRD366WVGU	PRD364WDGU	PRD486WIGU	PRD486WDGU	PRD606WEG	PRG366WG	PRG486WDG
	PARKB48CGY Blue Knob Kit 48" Combi Grand	384	429	•					•	•				
	PARKB48SGY Blue Knob Kit 48" Combi Steam Grand	379	419		•							•		
	PARKB60CGY Blue Knob Kit 60" Combi Grand	349	389							•				
	PARKB60SGY Blue Knob Kit 60" Combi Steam Grand	349	389			•								
	PA36WTKG Toe Kick for 36" Pro Grand® Range	109	119				•	•	•			•		
	PA48WTKG Toe Kick for 48" Pro Grand® Range	109	119	•	•				•	•		•		
	PA60WTKG Toe Kick for 60" Pro Grand® Range	139	159			•				•				
	PA36WLBG 7" Low Backguard for 36" Gas/Dual-Fuel Pro Grand® Ranges	479	529				•	•	•			•		
	PA48WLBG 7" Low Backguard for 48" Pro Grand® Gas Ranges	509	599	•	•				•	•		•		
	PA60WLBG 7" Low Backguard for 60" for Pro Grand® Range	559	649			•				•				

NOTE: Models PCG305xx, PRD305xx, PRD606xx, PRG305xx, PRG304xx, PRD304xx, PRx488xx, PRlxxxxx are suitable for 0" rear clearance to combustible surfaces. All other models: when using the included Island Trim a minimum 6" (152 mm) rear clearance is required to a combustible surface. When installing against a combustible surface, a Thermador Low Backguard is required for a 0" rear clearance to the combustible surface. A Thermador Low Backguard must be purchased separately. A rear clearance to a surface covered in a noncombustible material (metal, ceramic tile, brick, marble, or stone) is 0" when using the included Island Trim. Clearances of less than 6" (152 mm) should be approved by the local codes and/or by the local authority having jurisdiction. Clearances from non-combustible materials are not part of the ANSI Z21.1 scope and are not certified by CSA.

The information contained in this document is BSH Home Appliances Corporation's proprietary and confidential information. The release or disclosure of this information without the prior written consent of BSH Home Appliances Corporation is strictly forbidden.

VENTILATION

MASTERPIECE® & PROFESSIONAL COLLECTIONS

		30"	36"	42"	48"	54"/60"
WALL	Low-Profile	 HMWB30WS	 HMWB36WS HMWB361WS		 HMWB481WS	
	Masterpiece®	 HMDW30WS	 HMDW36WS			
	Pro Grand®		 PH36GWS		 PH48GWS	 PH60GWS
	Pro Harmony®		 PH36HWS		 PH48HWS	
CHIMNEY WALL	Masterpiece®	 HMCB30WS	 HMCB36WS			
	Masterpiece®	 Hddb30WS	 Hddb36WS			
	Professional		 HPCN36WS		 HPCN48WS	
ISLAND	Masterpiece®		 HMIB36WS	 HMIB42WS		
CUSTOM INSERT	Masterpiece®	 VCI3B30ZS VCI6B30ZS	 VCI3B36ZS VCI6B36ZS			
	Professional		 VCIN36GWS	 VCIN42GWS	 VCIN48GWS	 VCIN54GWS VCIN60GWS
DOWNDRAFT	Masterpiece®	 UCVM30XS	 UCVM36XS UCVP36XS			

The information contained in this document is BSH Home Appliances Corporation's proprietary and confidential information. The release or disclosure of this information without the prior written consent of BSH Home Appliances Corporation is strictly forbidden.

This price list supersedes all previous price lists. Prices listed herein do not include applicable state or local taxes.

Model Number	Description	UMRP	MSRP
--------------	-------------	------	------

All Wall Hoods include the following features:

- Beautiful illumination with multi-level, LED lights
- Recessed sleek, smooth touch control panel that provides precise performance selection with 4-speed levels
- Automatic mode detects temperatures to adjust fan speed automatically
- 10-min. delay shut off whisk away lingering odors
- Check filter reminder light illuminates after 40 hours of operation

Accessory options available

- Built-in remote control panel, sold separate (see page 6-7)

All Masterpiece® Wall Hoods include these Additional features:

- Equipped with the Thermador Connected Experience by Home Connect™
- A perfect complement to the sleek Thermador Masterpiece® Series cooktops
- Brushed stainless steel
- Dishwasher-safe stainless steel covered mesh filters
- Noise Control Technology™
- Cooktop Hood-Sync Enabled
- Vertical ducting direction
- Integral blower included
- Convertible to recirculation, accessory sold separate (see page 6-3)

Masterpiece® Series

Drawer Under Cabinet Wall Hood

- A masterful blend of luxury and performance with a slide-out canopy design
- When the slide-out canopy is pushed back, it sits flush against surrounding cabinetry, and when pulled forward increases capture area
- Fan can be activated in the closed or open position
- 600 CFM integral blower included
- Transition to 6" round and backdraft damper included



HMDW36WS



HMDW30WS	30" Masterpiece®, Under Cabinet Drawer Wall Hood, 600 CFM	2,149	2,399
----------	---	-------	-------

HMDW36WS	36" Masterpiece®, Under Cabinet Drawer Wall Hood, 600 CFM	2,249	2,499
----------	---	-------	-------

Low-Profile Wall Hood

- Chiseled design that is 24" depth, 11" tall
- Approved for use with Professional Series Ranges and Rangetops
- 16" tall and 28"-65" tall telescopic duct cover accessory options available, sold separate (see page 6-3)
- Transition to 10" round and backdraft damper included



HMWB30WS



HMWB30WS	30" Low-Profile Wall Hood, 600 CFM	2,049	2,299
----------	------------------------------------	-------	-------









HMWB36WS	36" Low-Profile Wall Hood, 600 CFM	2,149	2,399
----------	------------------------------------	-------	-------

HMWB361WS	36" Low-Profile Wall Hood, 1000 CFM	2,249	2,499
-----------	-------------------------------------	-------	-------

HMWB481WS	48" Low-Profile Wall Hood, 1000 CFM	2,349	2,599
-----------	-------------------------------------	-------	-------



The information contained in this document is BSH Home Appliances Corporation's proprietary and confidential information. The release or disclosure of this information without the prior written consent of BSH Home Appliances Corporation is strictly forbidden.

This price list supersedes all previous price lists. Prices listed herein do not include applicable state or local taxes.

Model Number	Description	UMRP	MSRP	Drawer		Low Profile			
Accessories—Masterpiece® Series				HMDW30WS	HMDW36WS	HMWB30WS	HMWB36WS	HMWB361WS	HMWB481WS
	<p>Recirculation Accessories</p> <ul style="list-style-type: none"> When ducting is not feasible, kit brings filtered air back into kitchen Replace charcoal filter every 3-6 months depending on usage Charcoal filter replacement accessory available (see below) 								
	<p>RECHMWB30 Recirculation Kit for HMWB30WS Low-Profile Wall Hood, 30" Wide</p>	699	799			•			
	<p>RECHMWB36 Recirculation Kit for HMWB36WS Low-Profile Wall Hood, 36" Wide</p>	749	849				•		
	<p>RECHMDW30 Recirculation Kit for Masterpiece® HMDW Under Cabinet Drawer Hood, 30" Wide</p>	129	149	•					
	<p>RECHMDW36 Recirculation Kit for Masterpiece® HMDW Under Cabinet Drawer Hood, 36" Wide</p>	129	149		•				
	<p>CHFHMWDW30 Replacement Charcoal Filters For Masterpiece® HMDW Under Cabinet Drawer Hood, 30" Wide</p>	99	109	•					
	<p>CHFHMWDW36 Replacement Charcoal Filters For Masterpiece® HMDW Under Cabinet Drawer Hood, 36" Wide</p>	99	109		•				
	<p>Optional Stainless Steel Duct Cover</p> <ul style="list-style-type: none"> Available in 16" and 20"-54" telescoping heights Can be used with Low-Profile HMWBxxWS Series Wall Hoods 								
	<p>DCT3016W 16" Tall Duct Cover for Low-Profile Wall Hood, 30" Wide</p>	649	749			•			
	<p>DCT3616W 16" Tall Duct Cover for Low-Profile Wall Hood, 36" Wide</p>	659	749				•	•	
	<p>DCT4816W 16" Tall Duct Cover for Low-Profile Wall Hood, 48" Wide</p>	679	749						•
	<p>DC30MTW 28"×65" Tall Duct Cover for Low-Profile Wall Hood, 30" Wide</p>	749	849			•			

The information contained in this document is BSH Home Appliances Corporation's proprietary and confidential information. The release or disclosure of this information without the prior written consent of BSH Home Appliances Corporation is strictly forbidden.

This price list supersedes all previous price lists. Prices listed herein do not include applicable state or local taxes.

Model Number	Description	UMRP	MSRP	Drawer		Low Profile			
Accessories—Masterpiece® Series				HMDW30WS	HMDW36WS	HMWB30WS	HMWB36WS	HMWB361WS	HMWB481WS
	DC36MTW 28"×65" Tall Duct Cover for Low-Profile Wall Hood, 36" Wide	759	849				•	•	
	DC48MTW 28"×65" Tall Duct Cover for Low-Profile Wall Hood, 48" Wide	779	899						•

The information contained in this document is BSH Home Appliances Corporation's proprietary and confidential information. The release or disclosure of this information without the prior written consent of BSH Home Appliances Corporation is strictly forbidden.

This price list supersedes all previous price lists. Prices listed herein do not include applicable state or local taxes.

Model Number	Description	UMRP	MSRP
--------------	-------------	------	------

All Professional Wall Hoods Include these Additional Features:

- Add distinct flair to your kitchen with bold, stainless steel wall hoods with design that echoes the thoughtful details of your Thermador kitchen
- Powerfully Quiet® optional blower system accepts integral, inline, and remote blowers
- Vertical or horizontal ducting discharge possible
- 6" tall and 20"-54" tall telescopic duct cover accessory options available, sold separate (see page 6-7)
- Blower options sold separate and required to complete install. Works with the following blowers, sold separately (see page 6-6)
Integral: VTN1DZ, VTN2FZ
Inline: VT11FZ¹, VT12FZ
Remote: VTR1FZ, VTR2FZ
- Make-up air damper relay switch (120 V max)
- Transition to 10" round and backdraft damper included

- Accessory options available**
- Duct cover accessory options (see page 6-7)
 - Remote blower roof plates (see page 6-8)
 - 25-ft. remote & inline blower extension cable (see page 6-8)

Professional Series

Pro Harmony® Wall Hood

- Adds distinct flair to your kitchen with bold, stainless steel wall hoods with design that echoes the thoughtful details of your Thermador kitchen
- A perfect companion to Pro Harmony® Professional Ranges
- Pro-style 24" depth, 18" tall
- Commercial-style stainless steel baffle filters



PH36HWS

PH36HWS	36" Pro Harmony® Wall Hood, Optional Blower	2,349	2,599
PH48HWS	48" Pro Harmony® Wall Hood, Optional Blower	2,599	2,899

Pro Grand® Wall Hood

- Equipped with the Thermador Connected Experience by Home Connect™
- Adds distinct flair to your kitchen with bold, stainless steel wall hoods with design that echoes the thoughtful details of your Thermador kitchen
- Crafted to complete the ultimate cooking system with Pro Grand® Professional Ranges
- Pro-style 27" depth, 18" tall
- Two infrared, 175 W, Keep-Hot lamps (included)



PH36GWS









PH36GWS	36" Pro Grand® Wall Hood, Optional Blower	2,549	2,849
PH48GWS	48" Pro Grand® Wall Hood, Optional Blower	2,999	3,299
PH60GWS	60" Pro Grand® Wall Hood, Optional Blower	3,999	4,399

¹ The 600 CFM blower options are not available with the 60" hood

The information contained in this document is BSH Home Appliances Corporation's proprietary and confidential information. The release or disclosure of this information without the prior written consent of BSH Home Appliances Corporation is strictly forbidden.







This price list supersedes all previous price lists. Prices listed herein do not include applicable state or local taxes.

Model Number	Description	UMRP	MSRP	Masterpiece®		Professional		
				Downdraft		Wall	Chimney Wall	Custom Insert
				UCVMxxRS	UCVP36XS	PHxxxWS	HPCNxxWS	VCINxxGWS
Blowers								
	Integral Blowers <ul style="list-style-type: none"> Integrated into ventilation hood at the time of installation 							
VTN1DZ	400 CFM Integral Blower	709	799			•		
	VTN2FZ	1,000 CFM Blower	899	999			•	•
							•	•
Inline Blowers								
<ul style="list-style-type: none"> Blower can be mounted along the duct line between the kitchen and the exterior wall 25 ft. cable (EXTNCB25W) available for inline blower applications—sold separately (see page 6-8) For use with Thermador PHxxxWS, HPCNxxWS, VCINxxGWS, UCVMxxRS, and UCVP36XS Series hoods 								
	VTI1FZ	600 CFM Inline Blower, 6" duct size	709	799	•	•	• ¹	• ²
	VTI2FZ	1,000 CFM Inline Blower, 10" duct size	899	999	•	•	•	•
Remote Blowers								
<ul style="list-style-type: none"> For external roof or wall mount Roof mounting plate (RFPLTxxP) required for roof mount applications—sold separately (see page 6-8) 25 ft. cable (EXTNCB25W) available for inline blower applications—sold separately (see page 6-8) For use with Thermador PHxxxWS, HPCNxxWS, VCINxxGWS, UCVMxxRS, and UCVP36XS Series hoods 								
	VTR1FZ	600 CFM Remote Blower, 6" duct size	829	949	•	•	• ²	• ²
	VTR2FZ	1,000 CFM Remote Blower, 10" duct size	869	999	•	•	•	•

¹ The 600 CFM blower options are not available with the 60" hood





The information contained in this document is BSH Home Appliances Corporation's proprietary and confidential information. The release or disclosure of this information without the prior written consent of BSH Home Appliances Corporation is strictly forbidden.

This price list supersedes all previous price lists. Prices listed herein do not include applicable state or local taxes.

Model Number	Description	UMRP	MSRP	Pro Harmony		Pro Grand		
				PH36HWS	PH48HWS	PH36GWS	PH48GWS	PH60GWS
Accessories—Professional								
	<p>Optional Stainless Steel Duct Cover</p> <ul style="list-style-type: none"> Available in 6" and 20"-54" telescoping heights Can be used with PHxxxWS Pro Grand® and Pro Harmony® Series Wall Hoods 							
DC366W	6" Tall Duct Cover for Pro Wall Hoods, 36" Wide	489	539	•		•		
	DC486W	6" Tall Duct Cover for Pro Wall Hoods, 48" Wide	499	549		•	•	
	DC3689W	8' - 9' Ceilings Telescoping Duct Cover, 36" wide	509	599	•		•	
	DC4889W	8' - 9' Ceilings Telescoping Duct Cover, 48" wide	529	599		•	•	
	DC361012W	10' - 12' Ceilings Telescoping Duct Cover, 36" wide	659	749	•			
	DC481012W	10' - 12' Ceilings Telescoping Duct Cover, 48" wide	719	799		•	•	
	<p>Built-In Remote Control</p> <ul style="list-style-type: none"> Ability to vertically install on cabinetry or wall to control hood in a convenient location Built-in sleek, smooth remote touch control panel Compatible with HDDBxxWS, HMCBxxWS, HMDWxxWS, HMIBxxWS, HMWBxxWS, HMWBxx1WS, HPCNxxWS, PHxxxWS, and VCINxxGWS Series hoods Wired to hood Cable length: 30 ft. 							
REMCPW	Built-In Remote Control Accessory	319	359	•	•	•	•	•

The information contained in this document is BSH Home Appliances Corporation's proprietary and confidential information. The release or disclosure of this information without the prior written consent of BSH Home Appliances Corporation is strictly forbidden.

This price list supersedes all previous price lists. Prices listed herein do not include applicable state or local taxes.

Model Number	Description	UMRP	MSRP	Pro Harmony		Pro Grand		
				PH36HWS	PH48HWS	PH36GWS	PH48GWS	PH60GWS
Blower and Duct Accessories								
	<p>Remote & Inline Blower Extension Cable</p> <ul style="list-style-type: none"> 25-ft. extension cable for use between hood and inline or remote blower Supports PHxxxWS, HPCNxxWS, UCVMxxXS, UCVP36xS and VCINxxGWS series hoods. Cannot join two cables together for longer length. For use with blowers VT11FZ, VT12FZ, VTR1FZ, VTR2FZ. 							
EXTNCB25W	25-ft Remote & Inline Blower Extension Cable	119	139	•	•	•	•	•
	EXTNSET4 3-pc extension set for Inline and remote blowers	159	179	•	•	•	•	•
	<p>Roof Plates</p> <p>NOTE: Roof plate required for roof-mount application of remote blowers.</p>							
RFPLT600P	Roof mounting plate for remote blower VTR1FZ	129	149	•	•	•	•	•
	RFPLT1000P Roof mounting plate for remote blower VTR2FZ	159	179	•	•	•	•	•

The information contained in this document is BSH Home Appliances Corporation's proprietary and confidential information. The release or disclosure of this information without the prior written consent of BSH Home Appliances Corporation is strictly forbidden.

This price list supersedes all previous price lists. Prices listed herein do not include applicable state or local taxes.

Model Number	Description	UMRP	MSRP
--------------	-------------	------	------

All Chimney Wall Hoods include the following features:

- Beautiful illumination with multi-level, LED lights
- Dishwasher-safe filters
- Recessed sleek, smooth touch control panel that provides precise performance selection with 4-speed levels
- Automatic mode detects temperatures to adjust fan speed automatically
- 10-min. delay shut off whisk away lingering odors
- Check filter reminder light illuminates after 40 hours of operation
- Vertical ducting direction
- Built-in remote control panel accessory available, sold separate (see page 6-7)

All Masterpiece® Chimney Wall Hoods include these Additional features:

- Equipped with the Thermador Connected Experience by Home Connect™
- A perfect complement to the sleek Thermador Masterpiece® Series cooktops
- Brushed stainless steel
- Serves as the focal point of the room and can add a modern feel
- Cooktop Hood-Sync Enabled
- 600 CFM integral blower
- Adjustable telescopic chimney heights to fit up to 9-ft. tall ceilings
- Transition to 8" round and backdraft damper included
- Duct cover extension kit accessory for 9-ft. to 12-ft. tall ceilings available, sold separate (see page 6-12)
- Convertible to recirculation, accessory sold separate (see page 6-12)
- Hybrid mesh filters with stainless steel frame
- Vertical ducting direction

Masterpiece® Series

Pyramid Chimney Wall Hood

- Streamlined, contemporary, low-profile design with 5" pyramid canopy height
- Noise Control Technology™

HMCB30WS	30" Masterpiece® Pyramid Chimney Wall Hood, 600 CFM	2,499	2,749
HMCB36WS	36" Masterpiece® Pyramid Chimney Wall Hood, 600 CFM	2,599	2,899



HMCB30WS



Drawer Chimney Wall Hood

- A masterful blend of luxury and performance with unique slide-out canopy design that can be pushed back for increased head room or pulled forward for increased capture area
- Can be activated whether in the open or closed position
- Noise Control Deluxe™

Hddb30WS*	30" Masterpiece® Drawer Chimney Wall Hood, 600 CFM	2,899	3,199
Hddb36WS*	36" Masterpiece® Drawer Chimney Wall Hood, 600 CFM	3,099	3,449



Hddb30WS



* Installation Note: This product ships with two brackets to hold the movable canopy in place during shipping and installation. After installation, be sure to remove the brackets to operate the movable canopy.

The information contained in this document is BSH Home Appliances Corporation's proprietary and confidential information. The release or disclosure of this information without the prior written consent of BSH Home Appliances Corporation is strictly forbidden.

This price list supersedes all previous price lists. Prices listed herein do not include applicable state or local taxes.

Model Number	Description	UMRP	MSRP
--------------	-------------	------	------

All Professional Chimney Wall Hoods include these Additional features:

- Designed to match the bold, stainless steel aesthetic of Thermador Professional Series ranges and range tops
- Sculpted brushed stainless steel
- Creates a focal point in the room with a more contemporary-style feel
- Make-up air damper relay switch (120 V max)
- Transition to 10" round and backdraft damper included
- Duct cover accessory options available, sold separate (see page 6-11)
- Pro-style 24" depth, 18" tall
- Completes a comprehensive cooking system with Thermador Professional Ranges and Rangetops
- Powerfully Quiet® optional blower system accepts integral, inline, and remote blowers
- 6" tall, 18"– 35" tall telescopic, and 42"– 59" tall telescopic duct cover accessory options available, sold separate (see page 6-11)
- Blower options sold separate and required to complete install. Works with the following blowers, sold separately (see page 6-6)
Integral: VTN2FZ,
Inline: VT11FZ, VT12FZ
Remote: VTR1FZ, VTR2FZ

Accessory options available

- Remote blower roof plates (see page 6-12)
- 25-ft. remote & inline blower extension cable (see page 6-11)

Professional Series

Pro Grand® Chimney Wall Hood

HPCN36WS	36" Professional® Chimney Wall Hood, Optional Blower	3,099	3,449
HPCN48WS	48" Professional® Chimney Wall Hood, Optional Blower	3,599	3,999











HPCN36WS

The information contained in this document is BSH Home Appliances Corporation's proprietary and confidential information. The release or disclosure of this information without the prior written consent of BSH Home Appliances Corporation is strictly forbidden.

CHIMNEY WALL HOODS







This price list supersedes all previous price lists. Prices listed herein do not include applicable state or local taxes.

Model Number	Description	UMRP	MSRP	Masterpiece®				Pro Grand	
				Pyramid Wall		Drawer		Wall	
				HMCB30WS	HMCB36WS	Hddb30WS	Hddb36WS	HPCN36WS	HPCN48WS
Accessories									
	<p>Remote & Inline Blower Extension Cable</p> <ul style="list-style-type: none"> • 25-ft. extension cable for use between hood and inline or remote blower • Supports PHxxxWS, HPCNxxWS, UCVMxxXS, UCVP36xS and VCINxxGWS series hoods. • Cannot join two cables together for longer length. • For use with blowers VTI1FZ, VTI2FZ, VTR1FZ, VTR2FZ. 							•	•
	EXTNCB25W 25-ft Remote & Inline Blower Extension Cable	119	139						
	EXTNSET4 3-pc extension set for Inline and remote blowers	159	179					•	•
	<p>Duct Cover</p> <ul style="list-style-type: none"> • Available in 6" tall, 18"-35" tall telescopic, and 42"-59" tall telescopic heights • Can be used with HPCNxxWS Professional Series Chimney Wall Hoods 							•	
	CHMHP366W 6" Tall Duct Cover for Professional® Chimney Wall Hood, 36" Wide	499	549						
	CHMHP486W 6" Tall Duct Cover for Professional® Chimney Wall Hood, 48" Wide	509	599						•
	CHMHP36TW 18"×35" Tall Telescoping Duct Cover for Professional® Chimney Wall Hood, 36" Wide	649	749					•	
	CHMHP48TW 18"×35" Tall Telescoping Duct Cover for Professional® Chimney Wall Hood, 48" Wide	659	749						•
	CHMHP36XTW 42"×59" Tall Telescoping Duct Cover for Professional® Chimney Wall Hood, 36" Wide	719	799					•	
	CHMHP48XTW 42"×59" Tall Telescoping Duct Cover for Professional® Chimney Wall Hood, 48" Wide	739	849						•

The information contained in this document is BSH Home Appliances Corporation's proprietary and confidential information. The release or disclosure of this information without the prior written consent of BSH Home Appliances Corporation is strictly forbidden.

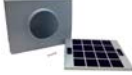
CHIMNEY WALL HOODS

This price list supersedes all previous price lists. Prices listed herein do not include applicable state or local taxes.

Model Number	Description	UMRP	MSRP	Masterpiece®				Pro Grand	
				Pyramid Wall		Drawer		Wall	
				HMCB30WS	HMCB36WS	HDDB30WS	HDDB36WS	HPCN36WS	HPCN48WS
Accessories									
	Chimney Wall Hood Extension Kits Stainless steel telescopic chimney extension for 9-ft. to 12-ft. tall ceilings CHXTHDDW 9'-12' Ceilings Chimney Extension Kit for HDDBxxWS Masterpiece® Chimney Drawer Hood	579	649			•	•		
	CHXTHMCB 9'-12' Ceilings Chimney Extension Kit for HMCBxxWS Masterpiece® Pyramid Chimney Hood	579	649	•	•				
	Chimney Wall Hood Recirculation Accessories <ul style="list-style-type: none"> When ducting is not feasible, kit brings filtered air back into kitchen Replace charcoal filter every 3-6 months depending on usage Charcoal filter replacement accessory available (see below) RECHDDB Recirculation Kit for Masterpiece® HDDBxxWS Drawer Chimney Wall Hood	159	179			•	•		
	RECHMCB Recirculation Kit for Masterpiece® HMCBxxWS Chimney Wall Hood	159	179	•	•				
	CHFHMCD Replacement Charcoal Filters For Masterpiece® HMCB, HDDB, HMIB Recirculation Kit	109	119	•	•	•	•		
	Roof Plates NOTE: Roof plate required for roof-mount application of remote blowers. RFPLT600P Roof mounting plate for remote blower VTR1FZ	129	149					•	•
	RFPLT1000P Roof mounting plate for remote blower VTR2FZ	159	179					•	•

The information contained in this document is BSH Home Appliances Corporation's proprietary and confidential information. The release or disclosure of this information without the prior written consent of BSH Home Appliances Corporation is strictly forbidden.

This price list supersedes all previous price lists. Prices listed herein do not include applicable state or local taxes.

Model Number	Description	UMRP	MSRP
--------------	-------------	------	------

All Island Hoods include the following features:

- Equipped with the Thermador Connected Experience by Home Connect™
- Beautiful illumination with multi-level, LED lights
- Recessed sleek, smooth touch control panel that provides precise performance selection with 4-speed levels
- Automatic mode detects temperatures to adjust fan speed automatically
- 10-min. delay shut off whisk away lingering odors
- Check filter reminder light illuminates after 40 hours of operation
- Vertical ducting direction
- Built-in remote control panel accessory available, sold separate (see page 6-7)

Masterpiece® Series

Low-Profile Island Hood

- Sleek and slim, these meticulously sculpted, floating stainless steel island hoods catch the eye without obstructing views
- A perfect complement to Thermador Masterpiece® Series cooktops
- Brushed stainless steel
- Cooktop Hood-Sync Enabled
- Noise Control Deluxe™
- 600 CFM integral blower
- Adjustable telescopic chimney heights to fit up to 9-ft. tall ceilings
- Transition to 8" round and backdraft damper included
- Convertible to recirculation, accessory sold separate (see page 6-14)

Accessory options available

- Duct cover extension kit accessory for 9-ft. to 12-ft. tall ceilings (see page 6-14)





HMIB36WS



HMIB36WS	36" Masterpiece® Box Island Hood, 600 CFM	3,399	3,749
HMIB42WS	42" Masterpiece® Box Island Hood, 600 CFM	3,499	3,849

The information contained in this document is BSH Home Appliances Corporation's proprietary and confidential information. The release or disclosure of this information without the prior written consent of BSH Home Appliances Corporation is strictly forbidden.

This price list supersedes all previous price lists. Prices listed herein do not include applicable state or local taxes.

Model Number	Description	UMRP	MSRP	Masterpiece®	
				Low Profile	
				HMIB36WS	HMIB42WS
Model Number	Description	UMRP	MSRP		
	Low-Profile Island Hood Extension Kit <ul style="list-style-type: none"> Stainless steel telescopic chimney extension for 9-ft to 12-ft tall ceilings Compatible with HMIBxxWS Masterpiece® Island Hood 				
	CHXTHMIB 9'-12' Ceilings Chimney Extension Kit for HMIBxxWS Masterpiece® Island Hood	699	799	•	•
	Low-Profile Island Hood Recirculation Accessories <ul style="list-style-type: none"> When ducting is not feasible, kit brings filters air back into kitchen Replace charcoal filter every 3-6 months depending on usage Compatible with HMIBxxWS Masterpiece® Island Hood Charcoal filter replacement accessory available (see below) 				
	RECHMIB Recirculation Kit for Masterpiece® HMIBxxWS Island Hood	159	179	•	•
	CHFHMCD Replacement Charcoal Filters For Masterpiece® HMCB, HDDB, HMIB Recirculation Kit	109	119	•	•

The information contained in this document is BSH Home Appliances Corporation's proprietary and confidential information. The release or disclosure of this information without the prior written consent of BSH Home Appliances Corporation is strictly forbidden.

This price list supersedes all previous price lists. Prices listed herein do not include applicable state or local taxes.

Model Number	Description	UMRP	MSRP
--------------	-------------	------	------

All Masterpiece® Custom Inserts include the following features:

- Equipped with the Thermador Connected Experience by Home Connect™
- Touch control
- Two 6 W LED lights
- Vertical ducting
- Integral blower
- 15 Amps
- 120 V
- Dishwasher-safe aluminum filter
- Perimetric filter
- Plug type: hardwire

Masterpiece® Series

300 CFM Custom Insert

- 300 CFM blower
- Vertical ducting with 6" round duct

VCI3B30ZS	30" Custom Insert Hood, 300 CFM	1,469	1,649
VCI3B36ZS	36" Custom Insert Hood, 300 CFM	1,569	1,749



VCI3B30ZS



VCI3B36ZS



600 CFM Custom Insert

- 600 CFM blower
- Vertical ducting with 8" round duct

VCI6B30ZS	30" Custom Insert Hood, 600 CFM	1,569	1,749
VCI6B36ZS	36" Custom Insert Hood, 600 CFM	1,669	1,849



VCI6B30ZS





VCI6B36ZS









The information contained in this document is BSH Home Appliances Corporation's proprietary and confidential information. The release or disclosure of this information without the prior written consent of BSH Home Appliances Corporation is strictly forbidden.

This price list supersedes all previous price lists. Prices listed herein do not include applicable state or local taxes.

Model Number	Description	UMRP	MSRP
<p>Custom Insert Hoods</p> <ul style="list-style-type: none"> Equipped with the Thermador Connected Experience by Home Connect™ Revel in creative freedom with custom inserts, whether you choose to blend them in with your surrounding cabinetry or create a statement piece with bold materials Crafted to complete the ultimate cooking system with Thermador Professional ranges and rangetops Brushed stainless steel Dishwasher-safe commercial-style stainless steel baffle filters Beautiful illumination with multi-level, LED lights Recessed sleek, smooth touch control panel that provides precise performance selection with 4-speed levels Automatic mode detects temperatures to adjust fan speed automatically 10-min. delay shut off whisk away lingering odors Check filter reminder light illuminates after 40 hours of operation Make-up air damper relay switch (120 V max) Powerfully Quiet® optional blower system accepts integral, inline, and remote blowers Includes custom hood trim to complete custom insert installation Vertical ducting Blower options sold separate and required to complete install. Works with the following blowers, sold separately (see page 6-6) Integral: VTN2FZ Inline: VT11FZ, VT12FZ Remote: VTR1FZ, VTR2FZ Transition to 10" round and backdraft damper included Built-in remote control panel accessory available, sold separate (see page 6-7) <p>Accessory options available</p> <ul style="list-style-type: none"> Remote blower roof plates (see page 6-8) 25-ft remote & inline blower extension cable (see page 6-8) 			
<p>Professional Series</p>  <p>VCIN48GWS</p> 			
VCIN36GWS	36" Professional® Custom Insert, Optional Blower	2,069	2,299
VCIN42GWS	42" Professional® Custom Insert, Optional Blower	2,169	2,399
VCIN48GWS	48" Professional® Custom Insert, Optional Blower	2,269	2,499
VCIN54GWS	54" Professional® Custom Insert, Optional Blower	2,369	2,649
VCIN60GWS	60" Professional® Custom Insert, Optional Blower	2,469	2,749

The information contained in this document is BSH Home Appliances Corporation's proprietary and confidential information. The release or disclosure of this information without the prior written consent of BSH Home Appliances Corporation is strictly forbidden.

This price list supersedes all previous price lists. Prices listed herein do not include applicable state or local taxes.

Model Number	Description	UMRP	MSRP	Masterpiece®				Pro					
				VCI3B30ZS	VCI3B36ZS	VCI6B30ZS	VCI6B36ZS	VCI36GWS	VCI42GWS	VCI48GWS	VCI54GWS	VCI60GWS	
Accessories													
	<p>Built-In Remote Control</p> <ul style="list-style-type: none"> Ability to vertically install on cabinetry or wall to control hood in a convenient location Built-in sleek, smooth remote touch control panel Compatible with HDDBxxWS, HMCBxxWS, HMDWxxWS, HMIBxxWS, HMMWBxxWS, HMMWBxx1WS, HPCNxxWS, HPINxxWS, PHxxWS, and VCINxxGWS Series hoods Wired to hood Cable length: 30 ft. 	319	359					•	•	•	•		
	<p>Remote & Inline Blower Extension Cable</p> <ul style="list-style-type: none"> 25-ft. extension cable for use between hood and inline or remote blower Supports PHxxWS, HPCNxxWS, HPINxxWS, UCVmxxXS, UCVP36xS and VCINxxGWS series hoods. Cannot join two cables together for longer length. For use with blowers VTI1FZ, VTI2FZ, VTR1FZ, VTR2FZ. 	119	139					•	•	•	•		
	<p>EXTNSET4 3-pc extension set for Inline and remote blowers</p>	159	179					•	•	•	•		
	<p>Roof Plates NOTE: Roof plate required for roof-mount application of remote blowers.</p> <p>RFPLT600P Roof mounting plate for remote blower VTR1FZ</p>	129	149					•	•	•	•		
	<p>RFPLT1000P Roof mounting plate for remote blower VTR2FZ</p>	159	179					•	•	•	•		
	<p>Charcoal Filters</p> <p>CHFVCI30ZS Charcoal Filter Kit for 30" Custom Inserts VCI3B30ZS and VCI6B30ZS</p>	109	119	•		•							
	<p>CHFVCI36ZS Charcoal Filter Kit for 36" Custom Inserts VCI6B36ZS and VCI6B36ZS</p>	109	119		•		•						

The information contained in this document is BSH Home Appliances Corporation's proprietary and confidential information. The release or disclosure of this information without the prior written consent of BSH Home Appliances Corporation is strictly forbidden.

This price list supersedes all previous price lists. Prices listed herein do not include applicable state or local taxes.



Model Number	Description	UMRP	MSRP
--------------	-------------	------	------

All Downdrafts include the following features:

- Designed for installation with all Thermador cooktops except Professional Series
 - All models feature six possible discharge connections including front, side, down, and rear as well as recirculation
 - Stainless steel
 - Sleek, removable front filter panel design that act as a splatter shield
 - Dishwasher safe mesh filters
 - Three speeds
 - Convenient 10-minute time-delay shut-off feature
 - Filter maintenance reminder light
 - Automatic mode
 - Recirculation possible with electric and induction cooktops, Accessory Sold Separately (UCVRECIRC see page 6-19)
- Required To Complete The Installation:**
- Blower Options, Sold Separately. Works with the following blowers, sold separately (see page 6-20).
Integral: VTD600P
Inline: VT11FZ, VT12FZ
Remote: VTR1FZ, VTR2FZ
- Downdraft transitions may be required to complete the installation depending on exhaust direction & blower chosen: [see page 6-20]
CVTSIDE6 CVTRECT2
CVTSIDE8 CVTFRONT6
CVTSIDE10 CVTFRONT8
CVDUCT2 CVTFRONT10
- Accessory options available**
- Gas cooktop seal kit sold separately, required for installation with gas cooktops (UCV30ST, UCV36ST [see page 6-19])
 - 5' electrical panel extension cable (used to relocate electrical box) for front downward discharge installations, sold separately (EXTNCE5 [see page 6-22])
 - 25-ft remote & inline blower extension cable, sold separately (EXTNCB25W see page 6-22)

Masterpiece® Series





Downdraft Ventilation System

UCVM30XS	30" Masterpiece® Downdraft 15" Snorkel, Optional Blower	1,869	2,099	 UCVM30XS
UCVM36XS	36" Masterpiece® Downdraft 15" Snorkel, Optional Blower	2,069	2,299	 UCVM36XS
UCVP36XS	36" Masterpiece® Downdraft, Deluxe 18" Snorkel, Optional Blower LED Task Bar Lights	2,369	2,649	 UCVP36XS

NOTE: Transition required and sold separately for all remote and inline blower installations.

The information contained in this document is BSH Home Appliances Corporation's proprietary and confidential information. The release or disclosure of this information without the prior written consent of BSH Home Appliances Corporation is strictly forbidden.

This price list supersedes all previous price lists. Prices listed herein do not include applicable state or local taxes.

Model Number	Description	UMRP	MSRP	UCVM30XS	UCVM36XS	UCVP36XS
Components						
	<p>Downdraft Recirculation Kit</p> <ul style="list-style-type: none"> For use with 30" UCVM30XS, 36" UCVM36XS, and 36" UCVP36XS down-draft models only Works in wall or island applications When ducting is not feasible, kit brings filtered air back into kitchen after passing through a charcoal filter To be used only with Thermador downdrafts and integrated blower VTD600P. Do not use this recirculation kit with Gas Cooktops Module ships with one heavy duty charcoal filter and two metal grill vent plates Mounts to cabinet base, recesses into toe kick/socket area Fits in toe-kick/socket heights of 4" or taller Module and grill vent plate can be placed so air does not hit feet Blower and downdraft sold separately Replacement charcoal filters available, sold separately <p>UCVRECIRC Recirculation kit for downdraft UCVM30XS, UCVM36XS, UCVP36XS downdrafts only. VTD600P Blower required, sold separately. Replace filters every 3-6 months depending on usage with HDDFILTUC</p>	599	699	•	•	•
	<p>HDDFILTUC Charcoal filter replacement For use with UCVRECIRC recirculation kit (above)</p>	See Bosch Price List*		•	•	•
	<p>Gas Cooktop Seal Kit</p> <ul style="list-style-type: none"> For use with 30" UCVM30XS, 36" UCVM36XS, 36" UCVP36XS downdraft models only Required for installation with gas cooktops Includes trim bracket, seal, and 2 metal grills <p>UCV30ST 30" gas cooktop seal kit For UCVM30XS downdraft</p>	129	149	•		
	<p>UCV36ST 36" gas cooktop seal kit</p>	129	149		•	•

* Pricing for the Thermador accessory listed on this page can be found on the Bosch Price List, listed under the same SKU numbers.







The information contained in this document is BSH Home Appliances Corporation's proprietary and confidential information. The release or disclosure of this information without the prior written consent of BSH Home Appliances Corporation is strictly forbidden.

This price list supersedes all previous price lists. Prices listed herein do not include applicable state or local taxes.

Model Number	Description	UMRP	MSRP	UCVM30XS	UCVM36XS	UCVP36XS
Components						
	Integrated Blower VTD600P 600 CFM, 8" duct size flexible integrated blower Use with UCVM30XS, UCVM36XS, UCVP36XS downdrafts only	849	949	•	•	•
	Inline Blowers <ul style="list-style-type: none"> Blower can be mounted along the duct line between the kitchen and the exterior wall 25 ft. cable (EXTNCB25W) available for inline blower applications—sold separately (see page 6-22) For use with Thermador PHxxxWS, HPCNxxWS, HPINxxWS, VCINxxGWS, UCVMxxRS, and UCVP36XS Series hoods 					
	VTI1FZ 600 CFM Inline Blower, 6" duct size	709	799	•	•	•
	VTI2FZ 1,000 CFM Inline Blower, 10" duct size	899	999	•	•	•
	Remote Blowers <ul style="list-style-type: none"> For external roof or wall mount Roof mounting plate (RFPLTxxP) required for roof mount applications—sold separately (see page 6-22) 25 ft. cable (EXTNCB25W) available for inline blower applications—sold separately (see page 6-22) For use with Thermador PHxxxWS, HPCNxxWS, HPINxxWS, VCINxxGWS, UCVMxxRS, and UCVP36XS Series hoods 					
	VTR1FZ 600 CFM Remote Blower, 6" duct size	829	949	•	•	•
	VTR2FZ 1,000 CFM Remote Blower, 10" duct size	869	999	•	•	•
	Downdraft Transitions Transition(s) may be required to complete the installation of 30" UCVM30XS, 36" UCVM36XS, 36" UCVP36XS downdrafts depending on the discharge connection chosen in combination with the downdraft blower selected (see installation manual) For use with inline and remote blowers					
	CVTSIDE6 6" side/rear transition Rectangular 1 7/8" x 19" transition to 6" round for side, down and rear exhaust applications	199	219	•	•	•
	CVTSIDE8 8" side/rear transition Rectangular 1 7/8" x 19" transition to 8" round for side, down and rear exhaust applications	199	219	•	•	•





The information contained in this document is BSH Home Appliances Corporation's proprietary and confidential information. The release or disclosure of this information without the prior written consent of BSH Home Appliances Corporation is strictly forbidden.

This price list supersedes all previous price lists. Prices listed herein do not include applicable state or local taxes.

Model Number	Description	UMRP	MSRP	UCVM30XS	UCVM36XS	UCVP36XS
Components						
	CVTSIDE10 10" side/rear transition Rectangular 1 7/8" x 19" transition to 10" round for side, down and rear exhaust applications	199	219	•	•	•
	CVTFRONT6 6" round front plate Front rough-in plate for front downward exhaust applications	99	109	•	•	•
	CVTFRONT8 8" round front plate Front rough-in plate for front downward exhaust applications	99	109	•	•	•
	CVTFRONT10 10" round front plate Front rough-in plate for front downward exhaust applications	99	109	•	•	•
	CVDUCT2 2' rectangular duct Rectangular duct that is 2' long x 1 7/8" deep x 19" wide (CVDUCT2) required to connect CVTRECT2 to down-draft housing. Ability to use as an extension to exhaust through a cabinet or wall. To modify length, duct may be cut. CVTSIDE6, CVTSIDE8, or CVTSIDE10 may be used to connect CVTRECT2 to round ductwork	199	219	•	•	•
	CVTRECT2 Transition for rectangular duct Required to attach CVDUCT2 2' rectangular duct to downdraft housing	99	109	•	•	•

The information contained in this document is BSH Home Appliances Corporation's proprietary and confidential information. The release or disclosure of this information without the prior written consent of BSH Home Appliances Corporation is strictly forbidden.

This price list supersedes all previous price lists. Prices listed herein do not include applicable state or local taxes.

Model Number	Description	UMRP	MSRP	Integrated	Inline	Remote Blowers	Downdraft				
				VTD600P	VT11FZ	VTI2FZ	VTR1FZ	VTR2FZ	UCVM30XS	UCVM36XS	UCVP36XS
Blower Accessories											
	<p>Remote & Inline Blower Extension Cable</p> <ul style="list-style-type: none"> 25-ft. extension cable for use between hood and inline or remote blower Supports PHxxxWS, HPCNxxWS, HPINxxWS, UCVMxxXS, UCVP36xS and VCINxxGWS series hoods. Cannot join two cables together for longer length. For use with blowers VT11FZ, VTI2FZ, VTR1FZ, VTR2FZ. 	119	139		•	•	•	•	•	•	•
	<p>EXTNSET4</p> <p>3-pc extension set for Inline and remote blowers</p>	159	179		•	•	•	•			
	<p>Electrical Panel Extension Cable</p> <ul style="list-style-type: none"> For use with 30" UCVM30XS, 36" UCVM36XS, 36" UCVP36XS downdraft models only Cable connects a remotely located electrical panel to the downdraft during remote and inline blower motor installation applications Cable provides ability to connect electrical panel to the downdraft from a remote location with 5-feet during installation applications with downward duct discharge so the electrical panel is out of the way Extends electrical panel cable an additional 5' Ability to connect two cables together to make a 10' cable Not to be used to connect the downdraft with inline and remote blowers 	199	219						•	•	•
	<p>Roof Plates</p> <p>NOTE: Roof plate required for roof-mount application of remote blowers.</p> <p>RFPLT600P</p> <p>Roof mounting plate for remote blower VTR1FZ</p>	129	149				•				
	<p>RFPLT1000P</p> <p>Roof mounting plate for remote blower VTR2FZ</p>	159	179				•	•			

The information contained in this document is BSH Home Appliances Corporation's proprietary and confidential information. The release or disclosure of this information without the prior written consent of BSH Home Appliances Corporation is strictly forbidden.

This price list supersedes all previous price lists. Prices listed herein do not include applicable state or local taxes.

Model Number	Description	UMRP	MSRP
--------------	-------------	------	------

All Dishwashers include the following features:

- Superior washing and drying performance guaranteed
- Concealed controls
- Touch Controls
- Black-shimmer racks with 3-Step adjustment
- A highly flexible racking system
- 16 place settings
- 18/10 Stainless steel TallTub
- Powerfully Quiet® operation
- Sens-a-Wash®
- Advanced Triple Filtration System
- Leak Sensor and Auto Shut off
- HomeConnect Wi-Fi enabled/Home Connect™ app compatibility

Wash Cycles:

- Normal
- Auto
- Pots and Pans
- Quick

Options:

- 24-hour Delay Start
- Remote Start (Connected)
- Sanitize (NSF certified to remove up to 99.9% of bacteria)

Emerald Series

- 48 dBA
- Chef's Tool Drawer™ (third rack)
- Blue PowerBeam® "on" indicator
- ENERGY STAR® certified

Additional App-Only Cycles:

- Rinse, Machine Care

Additional Options:

- Extra Dry

Additional App-Only Options:

- Save Time

DWHD640EFM	24" Masterpiece® Stainless Steel Emerald®	1,399	1,549
DWHD640EFP	24" Professional Stainless Steel Emerald®	1,399	1,549
DWHD640EPR	24" Custom Panel Emerald® (Requires Custom Panel)	1,399	1,549



DWHD640EFM



DWHD640EFP



DWHD640EPR



Home Connect

Sapphire® Series

- 44 dBA
- Adjustable Chef's Tool Drawer™ (third rack)
- Flexible folding tines
- NEW ZoneControl™ Spray Arm
- Blue PowerBeam® "on" indicator
- Sapphire Glow® Interior Light
- Premium smooth glide ball bearing wheels on lower, upper and third rack
- ENERGY STAR® certified

Additional App-Only Cycles:

- Rinse, Machine Care, Glass

Additional Options:

- StarDry™ – with Zeolite™, an exclusive Thermador drying solution

Additional App-Only Options:

- Save Time

DWHD660EFM	24" Masterpiece® Stainless Steel Sapphire®	1,999	2,199
DWHD660EFP	24" Professional Stainless Steel Sapphire®	1,999	2,199
DWHD660EPR	24" Custom Panel Sapphire® with Push To Open feature (Requires Custom Pan)	1,999	2,199



DWHD660EFM



DWHD660EFP



DWHD660EPR





Home Connect

The information contained in this document is BSH Home Appliances Corporation's proprietary and confidential information. The release or disclosure of this information without the prior written consent of BSH Home Appliances Corporation is strictly forbidden.







BUILT-IN DISHWASHERS/ACCESSORIES

This price list supersedes all previous price lists. Prices listed herein do not include applicable state or local taxes.

Model Number	Description	UMRP	MSRP
Star Sapphire® Series			
<ul style="list-style-type: none"> • 42 dBA • Premium smooth glide ball bearing wheels on lower, upper and third rack • Adjustable Chef's Tool Drawer™ (third rack) • 18 wine glass capacity • Flexible folding tines • NEW ZoneControl™ Spray Arm • Time remaining PowerBeam® indicator 	<ul style="list-style-type: none"> • StarGlow interior light allows you to change the color & intensity to match the ambience of your kitchen via the Home Connect™ app • Crystal Protect® water softener system • ENERGY STAR® certified 	<p>Additional App-Only Cycles:</p> <ul style="list-style-type: none"> • Rinse, Machine Care, Glass <p>Additional Options:</p> <ul style="list-style-type: none"> • StarDry™ – with Zeolite™, an exclusive Thermador drying solution <p>Additional App-Only Options:</p> <ul style="list-style-type: none"> • Save Time 	 <p>DWHD661EFM</p>  <p>DWHD661EFP</p>  <p>DWHD661EPR</p>
DWHD661EFM	24" Masterpiece® Stainless Steel Star Sapphire®	2,499	2,749
DWHD661EFP	24" Professional Stainless Steel Star Sapphire®	2,499	2,749
DWHD661EPR	24" Custom Panel Star Sapphire® with Push To Open feature (Requires Custom Panel)	2,499	2,749



Home Connect

				Accessories		
	Model Number	Description		Emerald Series	Sapphire Series	Star Sapphire Series
	SGZ1010UC	Dishwasher Drain Hose Extension	See Bosch Price List*	•	•	•
	SMZ3IN1UC	Dishwasher Installation Kit with Junction Box, Supply Hose, Elbow	See Bosch Price List*	•	•	•
	SMZ5000	Dishwasher Accessory Kit with Extra-Tall-Item™ Sprinkler, Vase/Bottle Holder, Three Plastic Item Clips and Small Item Basket.	See Bosch Price List*	•	•	•
	SMZ5002UC	Fine Silverware Carafe with Clip for Emerald® dishwashers (clips onto lower rack)	See Bosch Price List*	•	•	•
	SMZPCJB1UC	Junction Box Kit (alternate to the 3-Prong Power Cord Kit)	See Bosch Price List*	•	•	•
	SMZSH1ABUC	Dishwasher Water Supply Hose	See Bosch Price List*	•	•	•

* Pricing for the Thermador dishwasher accessories listed on this page can be found on the Bosch Price List, listed under the same SKU numbers.

The information contained in this document is BSH Home Appliances Corporation's proprietary and confidential information. The release or disclosure of this information without the prior written consent of BSH Home Appliances Corporation is strictly forbidden.

This price list supersedes all previous price lists. Prices listed herein do not include applicable state or local taxes.

24HFGALBIN 1-16	DC4889W..... 6-7	MBCS..... 3-12	PALPKITGA..... 5-9
24PRODRAIL..... 1-16	DC361012W..... 6-7	MBT30CS..... 3-12	PALPKITGA6..... 5-10
30HFGALBIN 1-16, 1-18	DC481012W..... 6-7	MC30WP..... 3-13	PALPKITGGW..... 5-19
30PRODRAIL..... 1-16, 1-18	DCT3016W 6-3	MC30WS..... 3-13	PALPKITHA5..... 5-9
36HFGALBIN 1-16	DCT3616W 6-3	MD24BS..... 3-12	PALPKITHW..... 5-9
36PRODRAIL..... 1-16	DCT4816W 6-3	MD30BS..... 3-12	PALPKITHW5..... 5-9
	DWHD640EFM 7-1	ME301WS..... 3-2	PARKB3XHY 5-10
C	DWHD640EFP 7-1	ME301YP 3-2	PARKB3XIHB..... 5-10
CET305YB 4-6	DWHD640EPR..... 7-1	ME302WS..... 3-3	PARKB30HY 5-10
CET366YB 4-6	DWHD660EFM 7-1	ME302YP 3-3	PARKB36CGY..... 5-19
CHFHMCD 6-12, 6-14	DWHD660EFP 7-1	MED301LWS..... 3-2	PARKB36DHY..... 5-10
CHFHMMDW30 6-3	DWHD660EPR..... 7-1	MED301RWS..... 3-2	PARKB36GY 5-19
CHFHMMDW36 6-3	DWHD661EFM 7-2	MED301WS..... 3-2	PARKB36HY 5-10
CHFVCI30ZS 6-17	DWHD661EFP 7-2	MED302LWS..... 3-4	PARKB36IGY 5-19
CHFVCI36ZS 6-17	DWHD661EPR..... 7-2	MED302RWS..... 3-4	PARKB48CGY..... 5-20
CHMHP36TW..... 6-11		MED302WS..... 3-4	PARKB48CHY..... 5-10
CHMHP36XTW..... 6-11	E	MEDMC301WS..... 3-5	PARKB48DHY..... 5-10
CHMHP48TW..... 6-11	EXTNCB25W 6-8, 6-11, 6-17,	MEDMCW31WS 3-5	PARKB48SGY..... 5-20
CHMHP48XTW..... 6-11	6-22	MEDS301BS 3-6	PARKB60CGY..... 5-20
CHMHP366W..... 6-11	EXTNCE5..... 6-22	MEDS302BS 3-6	PARKB60SGY..... 5-20
CHMHP486W..... 6-11	EXTNSET4.. 6-8, 6-11, 6-17, 6-22	MEM301WS..... 3-5	PCG305W 5-2
CHXTHDDW 6-12		MS20HNDL20..... 1-21	PCG364WD..... 5-3
CHXTHMCB..... 6-12	F	MS22HNDL25..... 1-21	PCG366W 5-2
CHXTHMIB..... 6-14	FRAMEKIT10 .. 1-3, 1-5, 1-6, 1-13,	MS30HNDL20..... 1-15	PCG486WD..... 5-3
CIT30FBG 4-4	1-16, 1-17, 1-18, 1-21	MS36HNDL20..... 1-15	PH36GWS..... 6-5
CIT30YWBB 4-3	FRAMEKIT30 1-18	MS3000IB10 1-19	PH36HWS..... 6-5
CIT36YWB 4-3		MS3600IB10 1-19	PH48GWS..... 6-5
CIT36YWBB 4-3	H	MS3642IT10..... 1-19	PH48HWS..... 6-5
CIT304BB..... 4-5	HDDDB30WS 6-9	MS4800IT10..... 1-19	PH60GWS..... 6-5
CIT304BB..... 4-5	HDDDB36WS 6-9	MU30WSU 3-13	PO301W..... 3-7
CIT304YB..... 4-5	HDDFILTUC 6-19		PO302W..... 3-8
CIT304YM..... 4-5	HEATRKIT20... 1-3, 1-5, 1-6, 1-13,	P	POD301LW 3-7
CIT365BB..... 4-6	1-16, 1-17, 1-18, 1-21	PA12CHPBLK 5-9, 5-18	POD301RW..... 3-7
CIT365YB..... 4-5	HMCB30WS..... 6-9	PA12GRILFW..... 5-9, 5-18	POD301W 3-7
CIT367YG..... 4-4	HMCB36WS..... 6-9	PA12GRILLW 5-9, 5-18	POD302LW 3-8
CIT367YGS..... 4-4	HMDW30WS..... 6-2	PA12LCVRW 5-9, 5-19	POD302RW..... 3-8
CIT367YM..... 4-4	HMDW36WS..... 6-2	PA24CVRR 5-19	POD302W..... 3-8
CIT367YMS..... 4-4	HMIB36WS 6-13	PA30WLBC 5-11	PODMC301W..... 3-9
COMBIKIT10..... 1-18	HMIB42WS 6-13	PA30WLBH 5-11	PODMCW31W 3-10
CVDUCT2 6-21	HMWB30WS 6-2	PA36WLBC 5-11	PODS301B..... 3-11
CVTFRONT6..... 6-21	HMWB36WS 6-2	PA36WLBG 5-20	PODS302B..... 3-11
CVTFRONT8..... 6-21	HMWB361WS..... 6-2	PA36WLBH 5-11	POM301W..... 3-9
CVTFRONT10..... 6-21	HMWB481WS..... 6-2	PA36WTKG 5-20	PR20HNDL20..... 1-21
CVTRECT2 6-21	HPCN36WS 6-10	PA48WLBC 5-11	PR22HNDL25..... 1-21
CVTSIDE6..... 6-20	HPCN48WS 6-10	PA48WLBG 5-20	PR30HNDL20..... 1-15
CVTSIDE8..... 6-20		PA48WLBH 5-11	PR36HNDL20..... 1-15
CVTSIDE10..... 6-21	I	PA48WTKG 5-20	PR3000IB10..... 1-19
	ICEBUCKETL..... 1-17, 1-18	PA60WLBG 5-20	PR3600IB10..... 1-19
D		PA60WTKG 5-20	PR3642IT10 1-19
DC30MTW 6-3	L	PAALTKITGW..... 5-19	PR4800IT10 1-19
DC36MTW 6-4	LPRODBIN10..... 1-16, 1-18	PAALTKITH 5-10	PRD48WDSGU..... 5-13
DC48MTW 6-4		PAGRIDDLE..... 5-9, 5-18	PRD48WISGU..... 5-13
DC366W..... 6-7	M	PAKNOBLUWR 5-10	PRD304WHU 5-5
DC486W..... 6-7	MB30WP 3-12	PALPKITDGW 5-19	PRD305WHU 5-5
DC3689W..... 6-7	MB30WS 3-12		

The information contained in this document is BSH Home Appliances Corporation proprietary and confidential information. The release or disclosure of this information without the prior written consent of BSH Home Appliances Corporation is strictly forbidden.

This price list supersedes all previous price lists. Prices listed herein do not include applicable state or local taxes.

PRD364WDGU 5-15	SMZSH1ABUC..... 7-2	T42BT120NS..... 1-9	VT11FZ.....6-6, 6-20
PRD364WDHU..... 5-6	SNPKITPEDW..... 4-7	T42IT100NP 1-9	VT12FZ.....6-6, 6-20
PRD364WIGU 5-15	SPRODBIN10..... 1-16, 1-18	T48BT110NS 1-9	VTN1DZ..... 6-6
PRD366WGU..... 5-15	SWOKRINGW..... 4-7	T48BT120NS 1-9	VTN2FZ..... 6-6
PRD366WHU 5-6		T48IT100NP 1-9	VTR1FZ.....6-6, 6-20
PRD486WDGU 5-16	T	TCM24PS 2-1	VTR2FZ.....6-6, 6-20
PRD486WDHU..... 5-6	T18ID905LP..... 1-4	TCM24TS 2-1	
PRD486WIGU 5-16	T18ID905RP..... 1-4	TCMTK30RS 2-1	W
PRD606WEG 5-16	T18IF905SP..... 1-4	TCOOKSENSW..... 4-7	WD30W3-14
PRD606WESG..... 5-13	T18IW905SP 1-12	TEPPAN1321..... 4-7	WD30WC3-14
PRG304WH..... 5-7	T18WINERK1 1-21	TFL18ID800..... 1-5	WKNOKBT3W.....3-14
PRG305WH..... 5-7	T24ID905LP..... 1-4	TFL18ID905..... 1-5	
PRG364WDH..... 5-8	T24ID905RP..... 1-4	TFL18IR800..... 1-5	
PRG366WG 5-17	T24IF905SP..... 1-4	TFL18IR905..... 1-5	
PRG366WH..... 5-8	T24IR905SP 1-2	TFL18IW800..... 1-13	
PRG486WDG..... 5-18	T24IW905SP 1-12	TFL18IW905..... 1-13	
PRG486WDH..... 5-8	T24UC905DP 1-14	TFL24ID800..... 1-5	
PRI30LBHU..... 5-4	T24UC915DS 1-14	TFL24ID905..... 1-5	
PRI36LBHU..... 5-4	T24UC925DS 1-14	TFL24IR800..... 1-3, 1-5	
PWOKRINGHC 5-9, 5-19	T24UR905DP 1-14	TFL24IR905..... 1-3, 1-5	
	T24UR905LP 1-14	TFL24IW800..... 1-13	
R	T24UR905RP 1-14	TFL24IW905..... 1-13	
RECHDDB..... 6-12	T24UR915DS 1-14	TFL30IB800..... 1-6	
RECHMCB 6-12	T24UR915LS 1-14	TFL30IB905..... 1-6	
RECHMDW30 6-3	T24UR915RS 1-14	TFL30IR800..... 1-3, 1-5	
RECHMDW36 6-3	T24UR925DS 1-14	TFL30IR905..... 1-3, 1-5	
RECHMIB..... 6-14	T24UR925LS 1-14	TFL36IB100..... 1-20	
RECHMWB30 6-3	T24UR925RS 1-14	TFL36IR900..... 1-3, 1-5	
RECHMWB36 6-3	T24UW905LP 1-14	TFL36IR905..... 1-3, 1-5	
REMCPCW 6-7, 6-17	T24UW905RP..... 1-14	TFL36IT100 1-20	
REPLFLTR55 1-17, 1-19, 1-20	T24UW915LS 1-14	TFL42IT100 1-20	
RFPLT600P. 6-8, 6-12, 6-17, 6-22	T24UW915RS..... 1-14	TFL48IT100 1-20	
RFPLT1000P..... 6-8, 6-12, 6-17, 6-22	T24UW925LS 1-14	TWO30YS.....3-6, 3-14	
	T24UW925RS..... 1-14		
	T24WINERK1 1-21	U	
S	T30BB915SS..... 1-7	UCTRFLTR10..... 1-21	
SD30WC 3-14	T30BB925SS..... 1-7	UCV30ST 6-19	
SDS30WC..... 3-14	T30IB100SP 1-7	UCV36ST 6-19	
SGRIDDLEW..... 4-7	T30IB905SP 1-6	UCVM30XS 6-18	
SGS305TS 4-1	T30IF905SP..... 1-4	UCVM36XS 6-18	
SGS365TS 4-1	T30IR905SP 1-2	UCVP36XS 6-18	
SGSP305TS..... 4-2	T36BB110SS 1-8	UCVRECIRC..... 6-19	
SGSP365TS..... 4-2	T36BB120SS..... 1-8		
SGSX305TS..... 4-1	T36BT110NS 1-8	V	
SGSX365TS..... 4-1	T36BT120NS..... 1-8	VC13B30ZS..... 6-15	
SGSXP305TS 4-2	T36FL810NS 1-10	VC13B36ZS..... 6-15	
SGSXP365TS 4-2	T36FL821NS 1-10	VC16B30ZS..... 6-15	
SGZ1010UC..... 7-2	T36FT810NS 1-10	VC16B36ZS..... 6-15	
SKNOBLUW..... 4-7	T36FT820NS 1-10	VCIN36GWS 6-16	
SLPKITW..... 4-7	T36IB100SP 1-8	VCIN42GWS 6-16	
SMZ3IN1UC..... 7-2	T36IF905SP..... 1-4	VCIN48GWS 6-16	
SMZ5000..... 7-2	T36IR905SP 1-2	VCIN54GWS 6-16	
SMZ5002UC..... 7-2	T36IT100NP 1-8	VCIN60GWS 6-16	
SMZPCJB1UC 7-2	T42BT110NS 1-9	VTD600P 6-20	

The information contained in this document is BSH Home Appliances Corporation proprietary and confidential information. The release or disclosure of this information without the prior written consent of BSH Home Appliances Corporation is strictly forbidden.



BSH Home Appliances Corporation

1901 Main Street, Suite 600, Irvine, CA 92614

Phone: (949) 440-7100

(800) 735-4328 Sales and Service

Thermador.com